

blueink

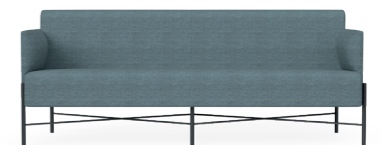

Soft Seating Collection

Aspirational design meets functional solutions.

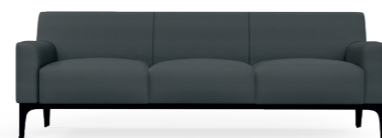
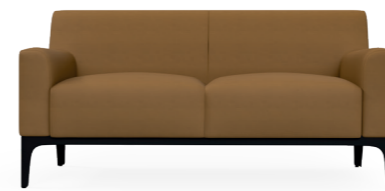

Contents

Introduction	7
Elaro	9
Elaro Lounge	10
Elaro Armchair	11
Mesa	12
Avalon	16
Cedar	20
Willow	24
Willow Modular Lounge	26
Willow Booth	30
Madison	32
Vista	36
Vista Tub	38
Vista Glide	40
Vista Barstool	42
Sofia	44
Grove	48
Custom Upholstery	54
Colour Guide	57
Longevity	58

- A** Elaro Armchair
- B** Plantation Coffee Table
- C** AcoustIQ Custom Print Panel
- D** Disc Coffee Table



Soft Seating Collection
**Elevating Commercial Spaces
with Purposeful Design.**



Designed with Intent

Blue Ink Group's Soft Seating Collection brings comfort, style, and performance to contemporary workspaces.

Purposefully designed with slimline profiles and organic forms, it delivers a refined residential aesthetic, combining the warmth of home with the durability demanded by commercial environments. From breakout areas to reception lounges and collaborative hubs, each piece supports a cohesive visual language, ensuring flow and harmony throughout your floorplan. Premium materials, ergonomic comfort, and modular flexibility make the collection as practical as it is beautiful.



Our in-house custom upholstery capability allows you to select from Blue Ink Group's Sunday Fabric Range, or specify your own, enabling you to realise your unique design intent. Our soft seating is built to elevate productivity, encourage connection, and integrate the most considered interiors.

Whether you're planning a full fit-out or refining key zones, welcome to soft seating that works seamlessly across zones while making a lasting design statement.

Elaro

Lounge & Armchair

A perfect fusion of contemporary design with soft curves and minimalist form, the Elaro blends elegance with functionality for today's contemporary workspaces.

Together, the Elaro Lounge and Armchair create a cohesive, modern seating pairing, ideal for reception areas, breakout zones, and collaborative environments.

Elaro Lounge Chair:

- Gently reclined high backrest for relaxed posture.
- Upholstered in Blue Ink Group's premium Sunday fabric.
- Integrated armrests and ergonomic contours.
- Ideal for reception areas, lounges, and executive boardrooms.

Elaro Armchair:

- Compact profile for smaller or flexible spaces.
- Wraparound backrest and contoured arms for support.
- Perfect for dining settings, collaborative zones, or casual meetings.

- A Elaro Lounge
- B Elaro Armchair
- C Cedar Lounge Chair

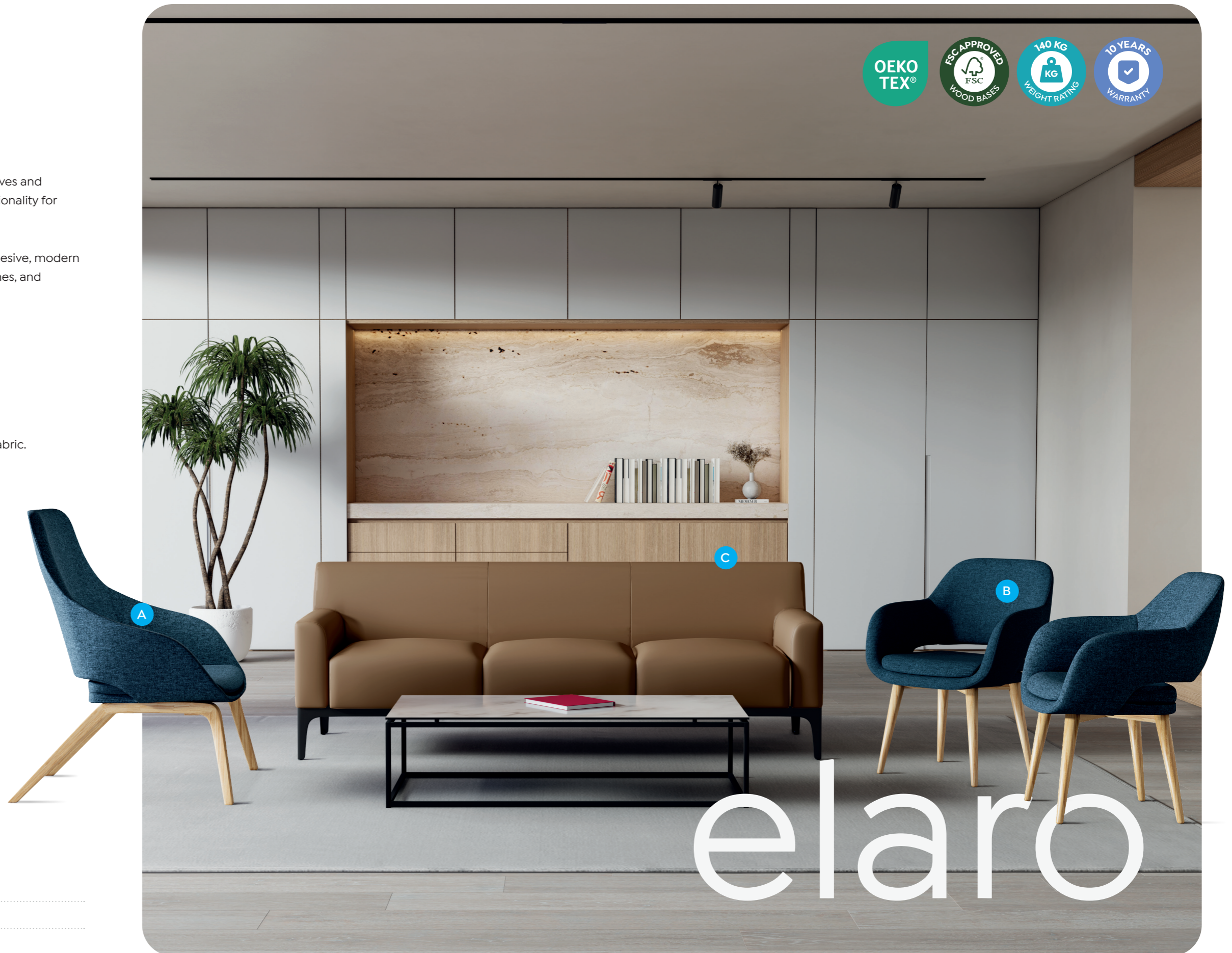

elaro

Elaro Lounge

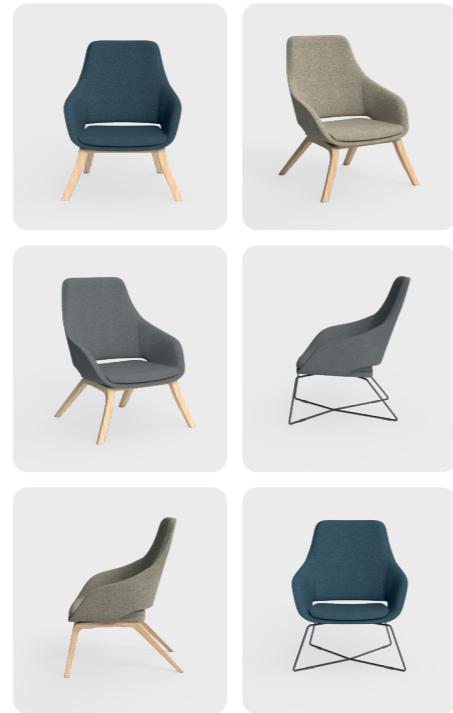

Features

Top-Tier Posture Support:
Supportive high-back with a gentle recline, providing exceptional comfort.

Exclusive Upholstery:
Experience the luxurious feel of Blue Ink Group's premium Sunday fabric.

Ergonomic Contours:
Designed with integrated armrests and ergonomic contours.

Styled for Impact:
Available in sleek black powder-coated metal or a warm wood finish to suit any aesthetic.

Designed for Versatility:
Ideal for creating a welcoming atmosphere in any professional space.

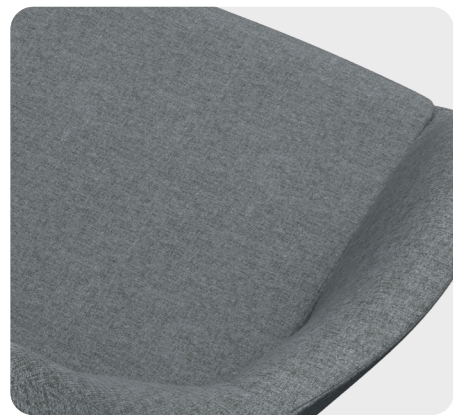

Dimensions

Base	Wooden	Metal
Width	770 mm	775 mm
Depth	770 mm	770 mm
Height	950 mm	940 mm
Seat Height	460 mm	410 mm

Colours

On-hand stocked and styled

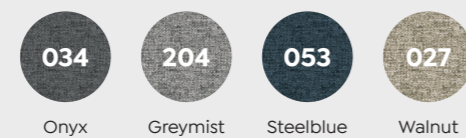

Base

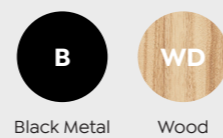

Elaro Armchair

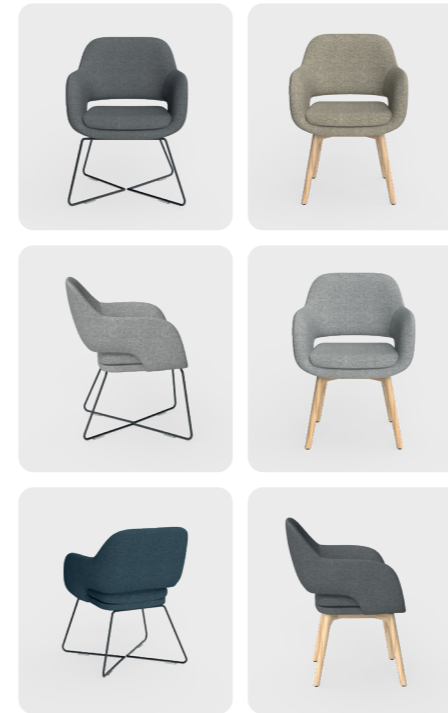

Features

Compact Profile:
Ideal for smaller spaces, offering a flexible and stylish solution.

Wraparound Backrest:
Experience superior comfort with the wraparound backrest and contoured arms.

Tailored for Flexibility:
Perfect for dining areas, collaborative spaces, or casual meeting zones.

Crafted for Comfort:
Ideal for fostering a warm, inviting atmosphere in any professional setting.

Styled for Impact:
Available in sleek black powder-coated metal or a warm wood finish to suit any aesthetic.



Dimensions

Base	Wooden	Metal
Width	635 mm	635 mm
Depth	640 mm	650 mm
Height	860 mm	830 mm
Seat Height	470 mm	460 mm

Colours

On-hand stocked and styled

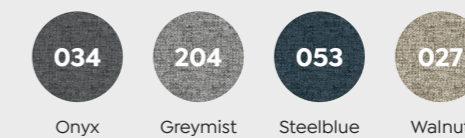

Base





Mesa

Stylish, compact, and supremely comfortable.

Blending form and function, this soft seating pair offers modern comfort with a refined aesthetic. Featuring a gently curved backrest, supportive arm profile, and a choice of base finishes, from warm timber legs to sleek powder-coated steel, this chair adapts seamlessly to both casual and professional environments.

Ideal for collaborative zones, meeting rooms, or breakout spaces, the chair comes in a two-tone upholstery option, allowing for creative combinations of texture and colour.



- A Mesa Chair
- B Breakout Table – Disc Base
- C AcoustiQ – Sonus Panels

Mesa Chair

Metal Base

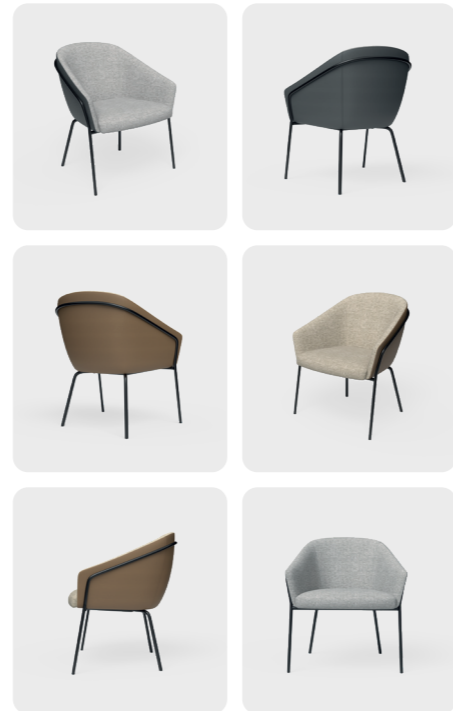

Features

Metal Base:
The black metal base delivers a clean, refined aesthetic that suits modern interiors with an industrial edge.

Enhance Comfort:
Ergonomic shell with soft foam padding provides excellent support for extended sitting.

Designed Flexibility:
Available in two-tone upholstery, to suit multiple interior palettes.

Durable Construction:
Engineered for commercial use with robust materials and high-quality finishes.

Multi-Functional Use:
Perfect for waiting areas, informal meeting spaces, collaborative hubs, and lounge settings.

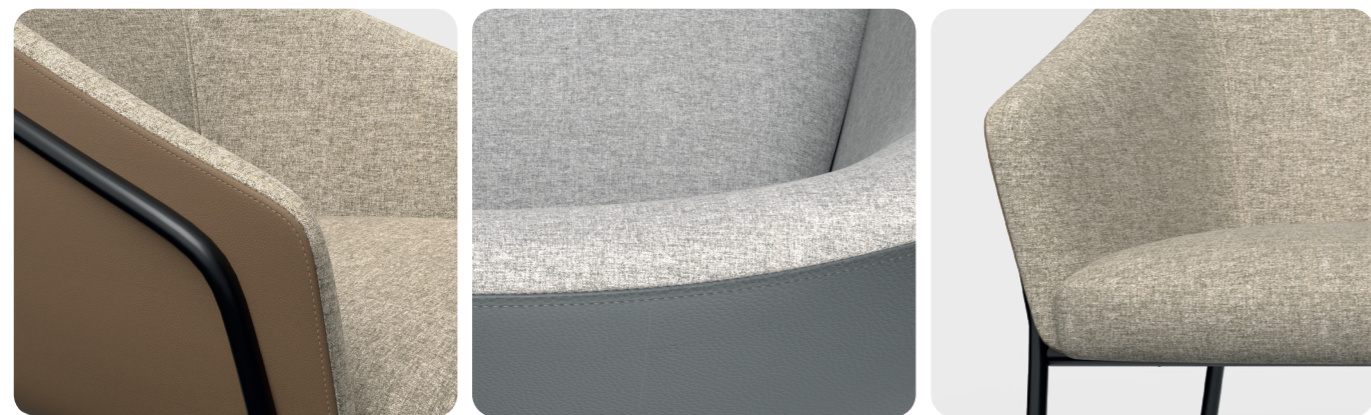

Dimensions

Base	Metal
Width	660 mm
Depth	650 mm
Height	795 mm
Seat Height	460 mm

Colours

On-hand stocked and styled



Tan PU Leather & Sunday Walnut Fabric



Charcoal PU Leather & Sunday Greymist Fabric

Metal Base



Black

Mesa Chair

Wooden Base

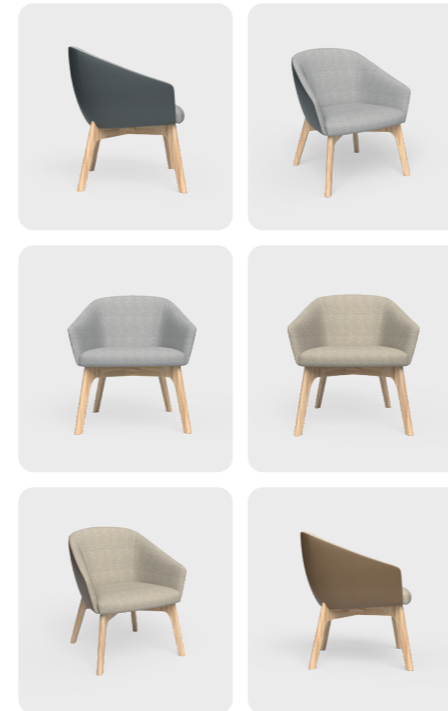

Features

Wooden Base:
Natural timber legs offer warmth and character.

Enhance Comfort:
Ergonomic shell with soft foam padding provides excellent support for extended sitting.

Designed Flexibility:
Available in two-tone upholstery, to suit multiple interior palettes.

Durable Construction:
Engineered for commercial use with robust materials and high-quality finishes.

Multi-Functional Use:
Perfect for waiting areas, informal meeting spaces, collaborative hubs, and lounge settings.

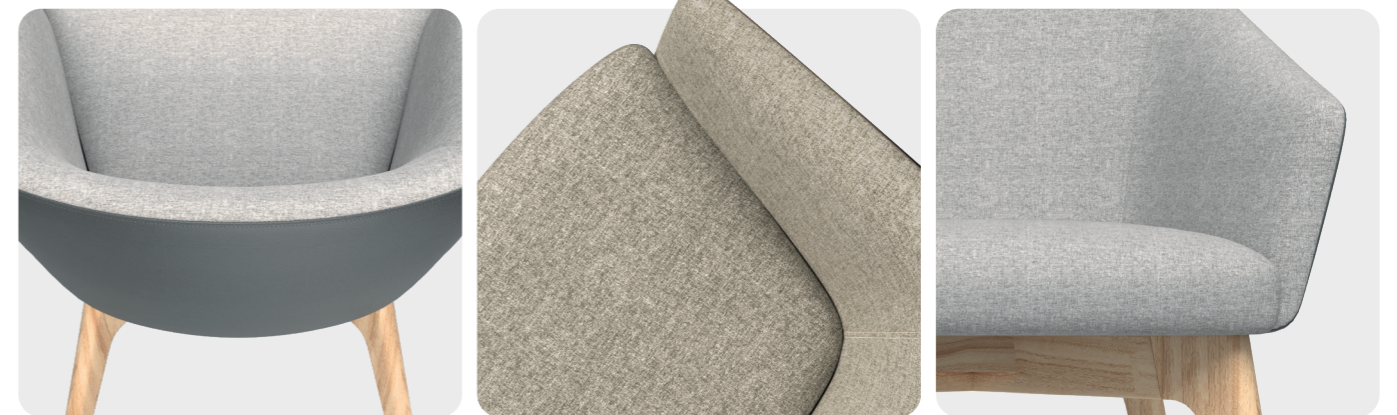

Dimensions

Base	Wood
Width	650 mm
Depth	630 mm
Height	800 mm
Seat Height	470 mm

Colours

On-hand stocked and styled



Tan PU Leather & Sunday Walnut Fabric



Charcoal PU Leather & Sunday Greymist Fabric

Base



Wood

Avalon

Avalon Sofa Series

A timeless solution designed with flexibility at its core, each piece can be used independently or combined to create a unified, inviting space.

Available in armchair, two-seater, and three-seater configurations, the Avalon provides maximum adaptability for reception areas, breakout zones, and collaborative lounges that balance aesthetics and functionality.



A Avalon 1-Seater

B Avalon 3-Seater



Avalon Sofa



Features

Consistent Visual Language:
Clean lines, bold upholstery, and sleek frames ensure a cohesive, professional look in any setting, easily adapts to suit different projects and spatial needs.

Configuration Options:
Choose from an individual armchair, two-seater or three-seater. Designed to function as standalone pieces or in grouped arrangements.

Ergonomic Contours:
Designed with integrated armrests and ergonomic contours.

Upholstery Options:
OTE VICO fabric in Ash Stone Grey, Dusty Grey, Sage Green, Ocean Blue.

Commercial Durability:
Engineered for high-traffic environments with a robust frame and commercial-grade materials.



Dimensions

	Armchair	2-Seater	3-Seater
Width	750 mm	1500 mm	1900 mm
Depth	750 mm	750 mm	750 mm
Height	775 mm	775 mm	775 mm
Seat Height	460 mm	460 mm	460 mm

Avalon Sofa



Colours

VICO On-hand stocked and styled

- 024 Ash Stone Grey
- 023 Dusty Grey
- 039 Sage Green
- 020 Ocean Blue

Metal Base

- B Black

Tailored for your space.



Our upholstery service allows you to customise with confidence. Select from our curated Sunday Fabric collection or supply your fabric of choice for a seamless design match. See page 54 to learn more.



Cedar

Classic comfort with a modern twist.

Classic comfort with a modern twist. Designed for today's high-traffic, public-facing environments, Cedar features clean lines, tailored upholstery, and durable PU finishes that are easy to maintain and built to last.

Available in one, two and three-seater configurations, Cedar adapts effortlessly to a range of commercial settings, from corporate receptions and hospitality lounges to client waiting areas.

Whether used individually or arranged as a cohesive set, Cedar provides a refined, professional presence in any space.

- A Cedar - 1 Seater
- B Cedar - 2 Seater
- C Cedar - 3 Seater
- D AcustiQ Sonus Panel

Cedar Lounge



Features

Flexible Modular Design:

Available in single, two and three-seater options to suit multiple settings.

Durable PU Upholstery:

Easy to clean and maintain. Ideal for high-use environments such as reception areas, lobbies, and public zones.

Contemporary Frame Finish:

Black metal base with stainless steel accents and angled legs, adds subtle elegance and strength.

Stylish Colour Options:

Choose from Charcoal PU or Tan PU to complement a variety of interior palettes.

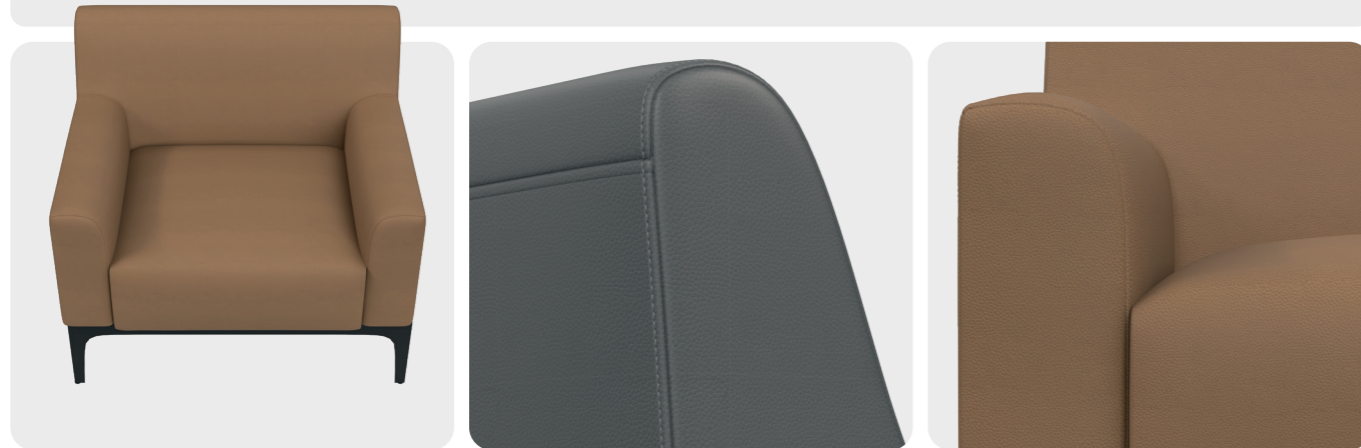

Dimensions

	Armchair	2-Seater	3-Seater
Width	860 mm	1450 mm	2070 mm
Depth	740 mm	740 mm	740 mm
Height	780 mm	780 mm	780 mm
Seat Height	430 mm	430 mm	430 mm

Cedar Lounge



Colours On-hand

Stocked & styled PU Leather

Metal Base

TPU (Tan) CHPU (Charcoal) B (Black)

Willow

Modular Lounge & Booth Series

The Willow Modular Lounge & Booth Series is crafted with adaptability and spatial intelligence in mind, offering a cohesive family of modular lounge seating and privacy booths.

Whether planning open-plan collaborative zones or quieter focus areas, Willow delivers a unified design language that enhances usability, acoustic comfort, and visual continuity.

Willow Modular Lounge

Adaptable modular seating for evolving spaces. Designed for flexibility, making it ideal for breakout areas, team zones and transitional areas. Willow's cohesive design language pairs seamlessly with the Willow Booth Series, enabling a coordinated, connected environment across open-plan interiors.

Willow Booth Series

The Willow Booth offers a refined balance of privacy and open-plan functionality. With its acoustic benefit and premium upholstery options, it creates dedicated zones for individual focus or small-group collaboration.

- A Willow Modular Lounge - Configuration 3
- B Willow Modular Lounge - Configuration 6
- C Willow Modular Lounge - Configuration 19
- D Willow Modular Lounge - Configuration 18
- E Plantation - Coffee Table
- F Vista Tub



willow

Willow Lounge

Modular Lounge



Features

Modular Configuration:

Modular configuration enables tailored layouts and future adaptability.

Collaborative Flexibility:

Enhances collaborative settings such as breakout zones and informal workspaces.

Base Alternatives:

Sturdy metal legs that may be wrapped in wood for an alternate finish.

Durable construction:

Engineered for commercial use, robust materials and high-quality fabric.

Enhance Comfort:

Ergonomic shell with soft foam padding, excellent support for extended sitting and high traffic areas.

Adaptive Design:

Integrates visually and functionally with the Willow Booth Series for unified spatial planning.

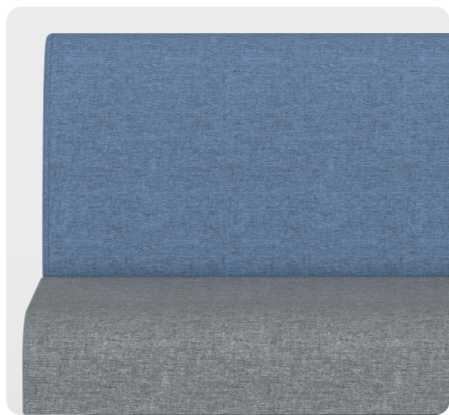
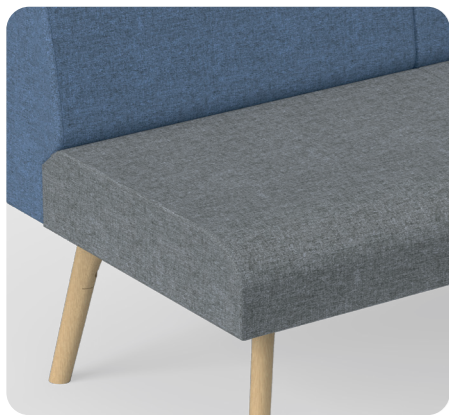

Colours

All seats are available only in Onyx colour.

On-hand stocked and styled

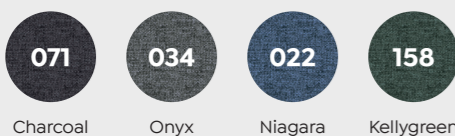

Base

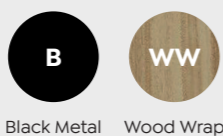

Tailored for your space.



Our upholstery service allows you to customise with confidence. Select from our curated Sunday Fabric collection or supply your fabric of choice for a seamless design match. See page 54 to learn more.

Willow Lounge

Modular Lounge

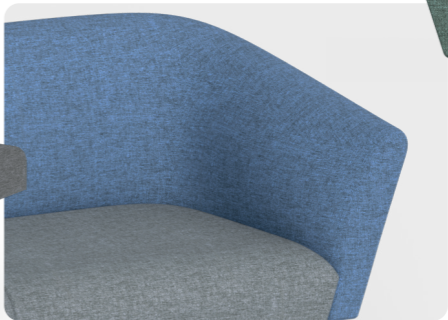
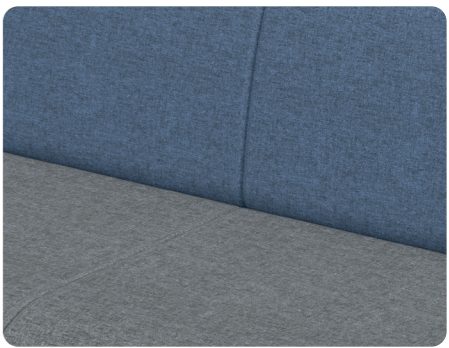

Willow Lounge

Configurations



- # = **B** - Black Frame
- # = **O** - Oak Frame
- ## = **KG** - Kelly Green
- ## = **CH** - Charcoal
- ## = **NA** - Niagara
- ## = **CUSTOM** - Your Fabric of Choice

1 OG_WML2BENCH#_FOX

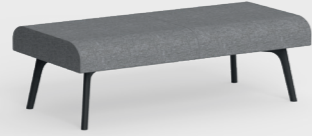

W1360 x D680 x H 430mm

2 OG_WML2STL#_##



W1360 x D680 x H780mm

3 OG_WML2SOFA#_##



W1680 x D680 x H780mm

4 OG_WML3BENCH#_FOX

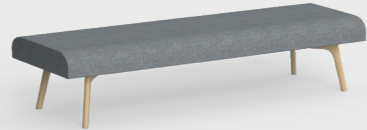

W2040 x D680 x H430mm

5 OG_WML3STL#_##



W2040 x D680 x H780mm

6 OG_WML3SOFA#_##

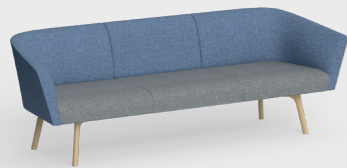

W2360 x D680 x H780mm

7 OG_WML4STL#_##



W2720 x D680 x H780mm

8 OG_WMLKIT001#_FOX##

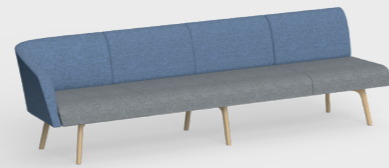

W2880 x D680 x H780mm

9 OG_WMLKIT002#_FOX##

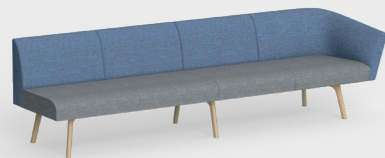

W2880 x D680 x H780mm

10 OG_WML4SOFA#_##



W3040 x D680 x H780mm

11 OG_WMLKIT003#_FOX##



W2880 x D680 x H780mm

12 OG_WMLKIT004#_FOX##



W2880 x D680 x H780mm

13 OG_WMLKIT005#_FOX##

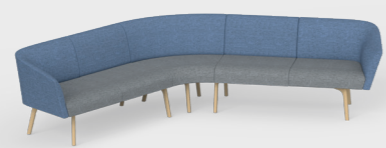

W2460 x D1530+680 x H780mm

14 OG_WMLKIT006#_FOX##



W2460 x D1360+680 x H780mm



Willow Lounge

Configurations

15 OG_WMLKIT007#_FOX##



W2460 + D1360 + D680 H780mm

16 OG_WMLKIT008#_FOX##



W4760 x D680 x H780mm

17 OG_WMLKIT009#_FOX##



W4257 x D2193 x H780mm

18 OG_WMLKIT010#_FOX##



W4243 x D2880 x H780mm

19 OG_WMLKIT012#_FOX##



W3400 x D2720 x H780mm

20 OG_WMLKIT011#_FOX##



W2720 x D1360 x H780mm

21 OG_WMLKIT013#_FOX##



W5040 x D3198 x H780mm

Willow Booth



Features

Privacy & Acoustics:

Provides privacy and acoustic comfort for focused activities.

Durable Construction:

Engineered for commercial use with robust materials and high-quality finishes.

Quiet Focus:

Ideal for quiet work zones or informal meetings.

Multi-Functional Use:

Designed for semi-private work, study or meeting areas.

Custom Upholstery:

Customisable upholstery options for cohesive interior palettes.

Base Alternatives:

Sturdy metal legs that may be wrapped in wood for an alternate finish.



Dimensions

Configuration	2-Seater	4-Seater
Width	1430mm	2200mm
Depth	715mm	1430mm
Height	1400mm	1400mm
Seat Height	430 mm	430 mm

Willow Booth

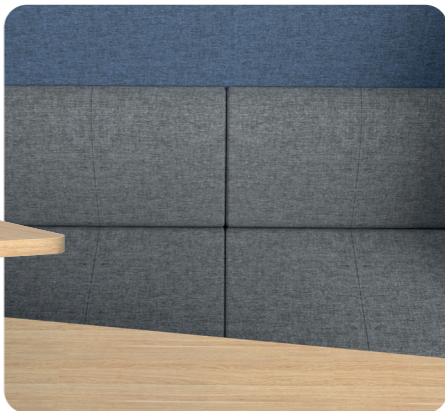
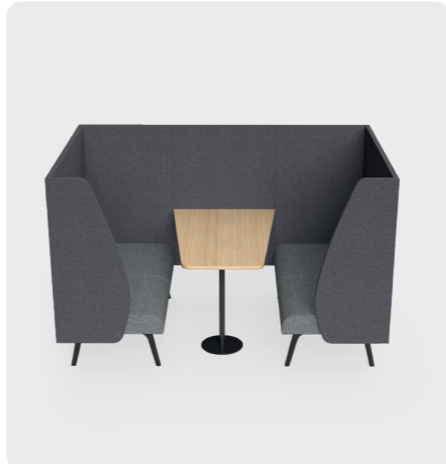

Colours

All seats are available only in Onyx colour.

On-hand stocked & styled

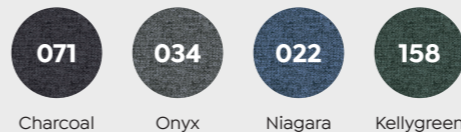

Base

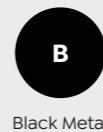

Tailored for your space.



Our upholstery service allows you to customise with confidence. Select from our curated Sunday Fabric collection or supply your fabric of choice for a seamless design match. See page 54 to learn more.



madison

Madison

Classic Simplicity, Crafted for Every Space.

Effortlessly blending timeless design with everyday functionality, the Madison range features clean lines, smooth finishes, and comfortable form. The Madison is designed to complement both professional and casual spaces alike, whether it's a bustling office lobby or breakout space.

Available in 1-seater and 2-seater options and crafted with a solid wooden frame and premium Charcoal PU upholstery, the Madison balances durability with a polished aesthetic. Designed for both comfort and functionality, it's the perfect solution for spaces where people gather, work, or unwind.



- A Madison - 1 Seater
- B Madison - 2 Seater
- C Plantation - Coffee Table
- D Sofia Chair - Gas Lift

Madison



Madison



Features

Sturdy Wooden Frame:

Built to last, the solid wooden frame ensures durability and stability, providing reliable support for years of use.

Space-Saving Nesting:

Soft, smooth, and easy to maintain, the Charcoal PU leather upholstery offers a clean and professional look with minimal upkeep.

Effortless Comfort:

Designed with comfort in mind, the Madison range is perfect for long hours of relaxation or productive conversations in lounges, lobbies, or reception areas.

Stylish Colour Options:

Its clean, straightforward design makes Madison a versatile choice, seamlessly fitting into a variety of spaces.



Dimensions

	1-Seater	2-Seater
Width	730 mm	1400 mm
Depth	710 mm	710 mm
Height	780 mm	780 mm
Seat Depth	520 mm	520 mm
Seat Height	440 mm	440 mm

Colours On Hand

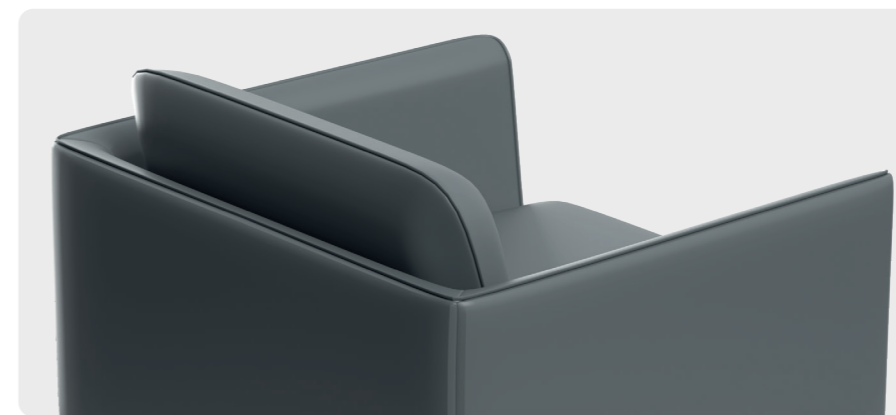
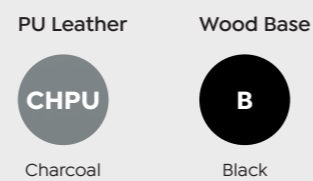

Vista

Contoured Comfort with Modern Appeal.

The Vista seating range blends refined design with everyday practicality. Characterised by its clean lines and contoured comfort, Vista offers a sophisticated seating solution for contemporary workspaces. Upholstered in Blue Ink Group's Sunday fabric, Vista ensures a cohesive and seamless aesthetic across workplace zones.



Vista Tub

The Vista Tub introduces sculptural form and comfort. Its smooth curves, wraparound profile and full upholstery create an inviting statement piece for lounges, reception areas, and quiet zones. With a pantone colour-matched base and commercial-grade finishes, the Vista Tub delivers both visual harmony and durable performance.

Vista Glide Chair & Vista Rise Barstool

Adding greater functionality to the collection, the Glide Chair and Rise Barstool are versatile, high-utility seating options.

Vista Glide Chair is stackable, lightweight, and built for high-turnover environments like training rooms, conferences, or lunch spaces. Its durable frame and easy setup make it a practical go-to for flexible workplace configurations.

Vista Rise Barstool offers elevated seating designed for casual, high-set spaces such as breakout zones, communal counters, and cafés. With its taller profile, the Rise encourages informal interaction while maintaining ergonomic support.

A Vista - Tub

B Willow - Lounge in wood wrapped legs



Vista Tub



Features

Distinctive Tub Design:
Unique to the Vista range, offering an inviting, enclosed seating style ideal for breakout and lounge areas.

Versatile Fit:
Generously proportioned for comfort, to accommodate a wide range of uses.

Premium Colour-Matched Base:
Features a PMS colour coordinated base, adding visual appeal and cohesion

Exclusive Upholstery Options:
Available in select colours from Blue Ink Group Sunday fabric for durability and style.



Dimensions

Width	620 mm
Depth	560 mm
Height	785 mm
Seat Height	450 mm

Colours

On-hand stocked and styled

<p>MS 158 Moss Base & Kellygreen Fabric</p>	<p>SK 022 Sky Base & Niagara Fabric</p>	<p>B 034 Black Base & Charcoal Fabric</p>
--	--	--

Vista Tub



Check out the complete Vista Range Visit blueinkgroup.com.au to learn more.

Vista Glide



Features

Distinctive Design:
High-quality materials and thoughtful design ensure lasting comfort in casual and collaborative settings.

Versatile Fit:
Generously proportioned for comfort, to accommodate a wide range of uses.

Premium Colour-Matched Base:
Features a colour coordinated base, adding a refined visual appeal.

Exclusive Upholstery Options:
Available in select colours from Blue Ink Group Sunday fabric for durability and style.

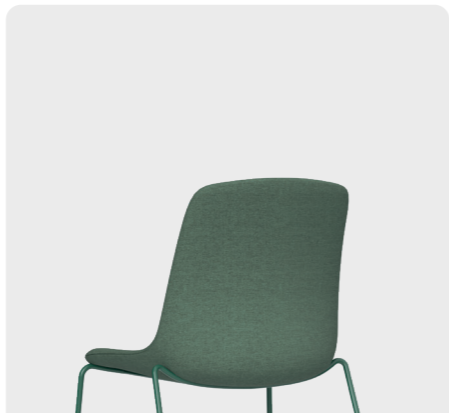

Dimensions

Width	540 mm
Depth	545 mm
Height	830 mm
Seat Height	475 mm

Vista Glide



Check out the complete **Vista Range**

Visit blueinkgroup.com.au to learn more.

Colours

On-hand stocked & styled

MS 158
Moss Base & Kellygreen Fabric

SK 022
Sky Base & Niagara Fabric

RU 066
Rust Base & Rust Fabric

W 039
White Base & Silver Fabric

B 071
Black Base & Charcoal Fabric

Vista Barstool



Features

Distinctive Design:

Offering a premium tailored look, the Barstool is ideal for cohesive seating needs.

Versatile Fit:

Generous proportioned for comfort, to accommodate a wide range of uses.

Premium Colour-Matched Base:

Features a colour coordinated base, adding a refined visual appeal.

Exclusive Upholstery Options:

Available in select colours from Blue Ink Group Sunday fabric for durability and style.



Dimensions

Width	540 mm
Depth	540 mm
Height	1140 mm
Seat Height	730 mm



Vista Barstool



Check out the complete **Vista Range**

Visit blueinkgroup.com.au to learn more.

Colours

On-hand stocked and styled

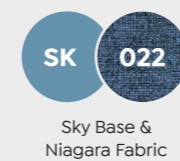
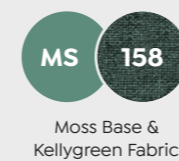



Sofia

Luxe Seating for Dynamic Environments.

Sofia adds a sophisticated edge to commercial interiors. Designed for flexibility and impact, Sofia is available in four base options and eight rich upholstery choices, across both premium PU Leather and soft-touch Sunday fabrics. Perfectly suited for meeting rooms, training zones, or visitor seating, Sofia delivers comfort without compromise.

- A Sofia Sled
- B Elaro Armchair

Sofia Sled



Features

Versatile Design:

Enhances any space with a luxurious and contemporary look.

Exceptional Comfort:

Crafted with high-quality materials for long-lasting comfort.

Perfect for any setting:

Ideal for conference rooms, training areas, meeting spaces, and waiting areas.

Wide Colour Selection:

Available in eight chic colours to suit a variety of colour palettes.

Base Colour Selection:

Four distinct base styles in black or white for add versatility.



Dimensions

Width	560 mm
Depth	650 mm
Height	840 mm
Seat Height	440 mm

Sofia Sled



Check out the complete **Sofia Range**

Visit blueinkgroup.com.au to learn more.

Colours On-hand

Stocked & styled PU Leather



Stocked & styled Sunday Fabric

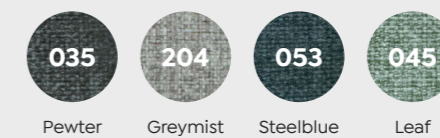

Base



Grove Sofa

Transform Your Workspace.

The Grove Sofa offers a modern, modular approach to commercial seating, suitable for contemporary commercial spaces.

Featuring soft curves and edges, it incorporates biophilic elements to create a visually appealing and inviting atmosphere. The system has matching plywood modular tables and planters, enabling natural wood accents to enhance visual appeal.

Built for durability, the Grove Range uses heavy-duty commercial fabric suitable for 24-hour use, ensuring long-lasting performance and comfort. With 90° and 60° corners, this sofa system accommodates various plan layouts, providing flexibility for any environment. Available in both double-sided and single-sided configurations.

The Grove Sofa combines style, functionality, and durability, making it an ideal choice for dynamic commercial spaces.



A Grove - Custom Configuration

B Rover Range - Whiteboard

C Rover Range - Mobile TV

D Willow Booth - 4-Seaters

E Willow Lounge - Configuration 3

F Vista Tub

G Disc Coffee Table

H Rhodes Modular Shelving

I SpacePod - 4-Person



Grove Sofa



Features

Modern, Modular Design:

Sleek, modular design enhances contemporary commercial spaces with flexibility and style.

Configuration Options:

Available in single, or double-sided setups to suit a range of layout needs.

Commercial Upholstery:

Heavy-duty commercial design for 24-hour use, ensuring durability and long-lasting comfort.

Matching Plywood Modular Tables and Planters:

Featuring built-in planters and tables with stainless inserts, adding functionality and natural timber accents to offices spaces.



Modules

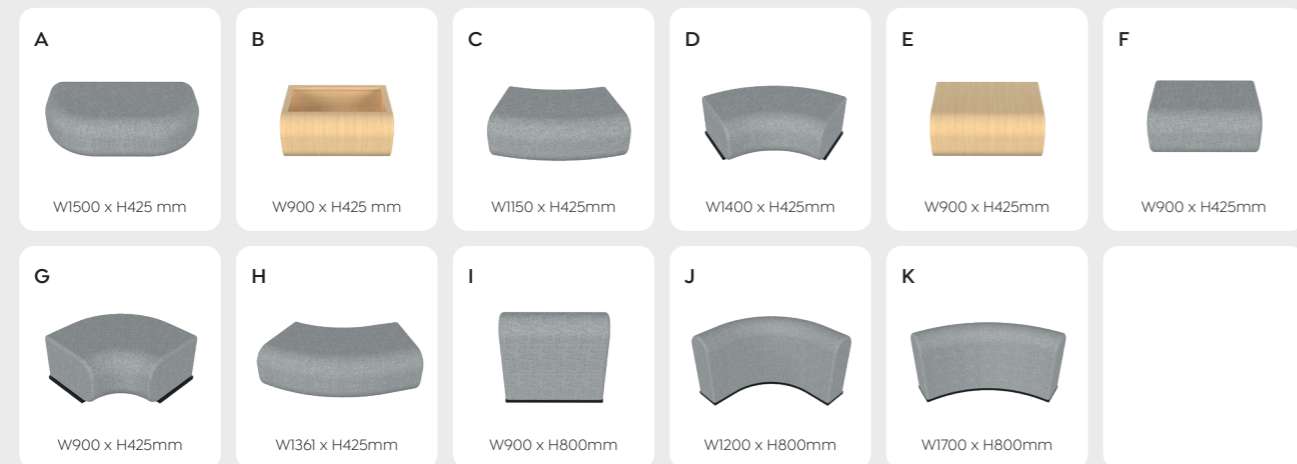

Grove Sofa



30/60 Degree Sofa

Plants not included

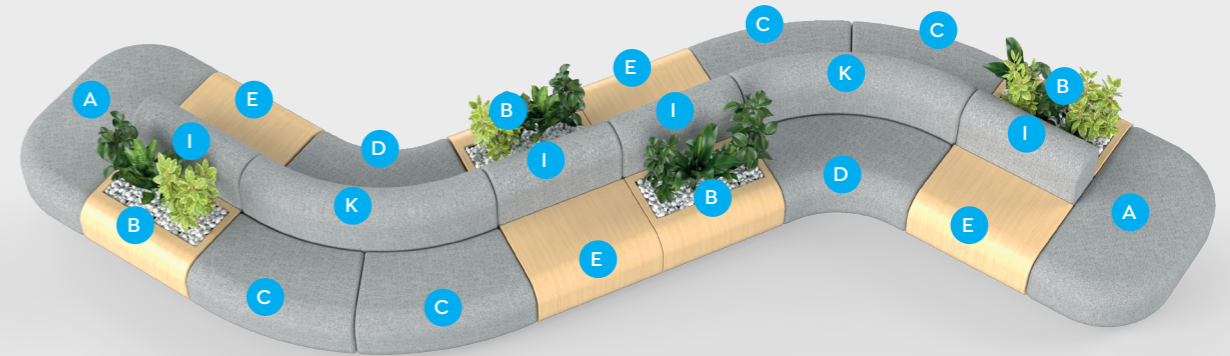

90 Degree Sofa

Plants not included

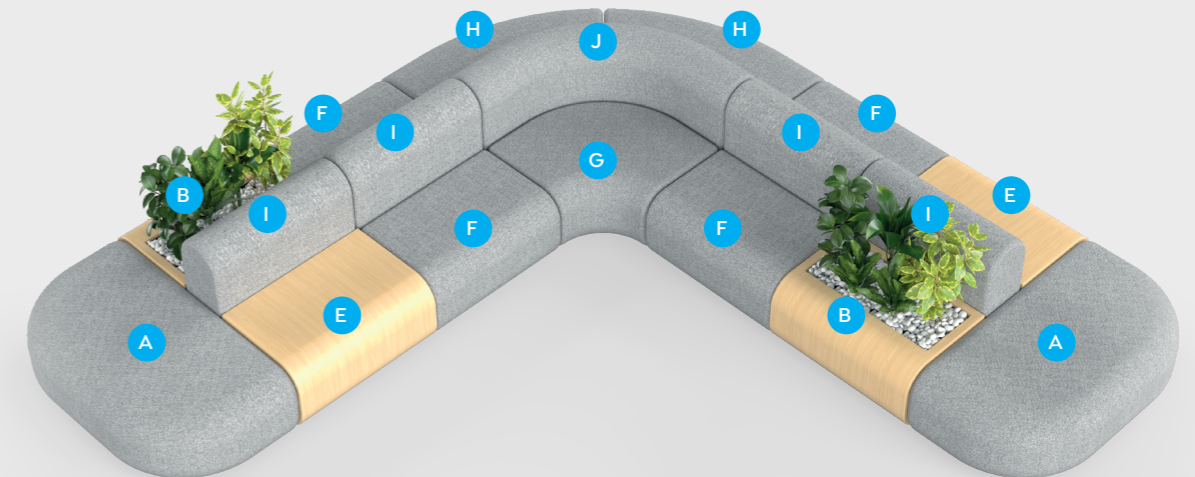

Colours On-hand

Stocked & styled

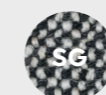

Spotted Grey Wool



Ash Grey

Tailored for your space.



Our upholstery service allows you to customise with confidence. Select from our curated Sunday Fabric collection or supply your fabric of choice for a seamless design match. See page 54 to learn more.

Grove Sofa

Configurations



Grove Sofa

Configurations

= **AG** - Ash Grey
 ## = **WGW** - Wool Grey White
 ## = **CUSTOM** - Your Fabric of Choice

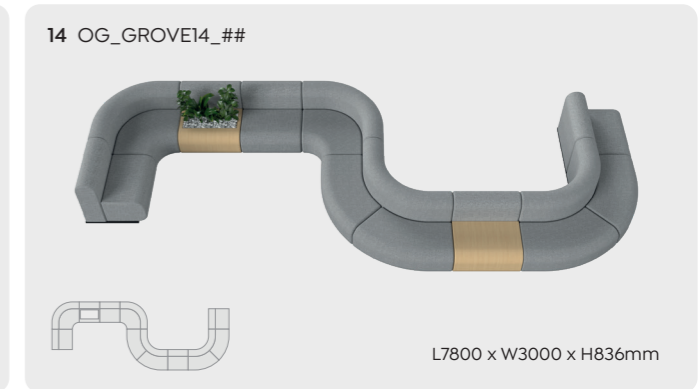
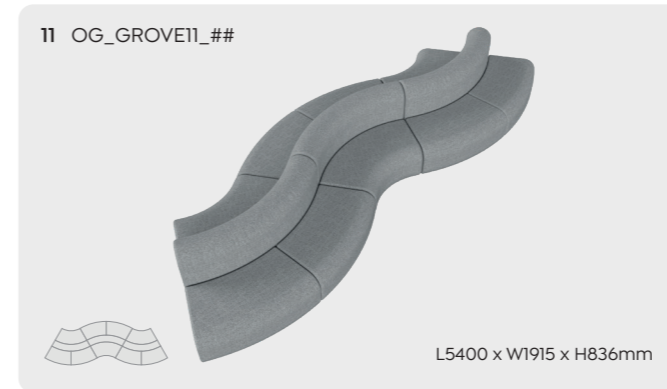
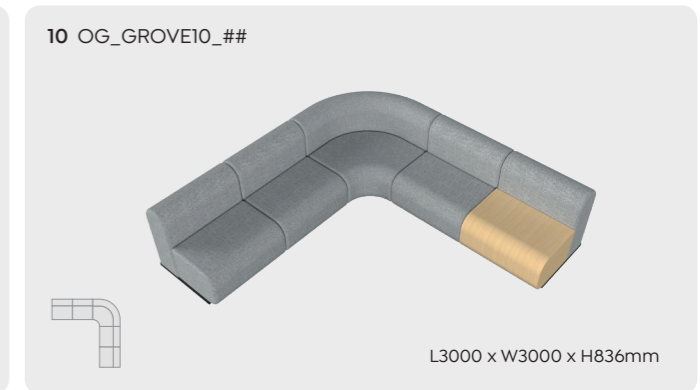
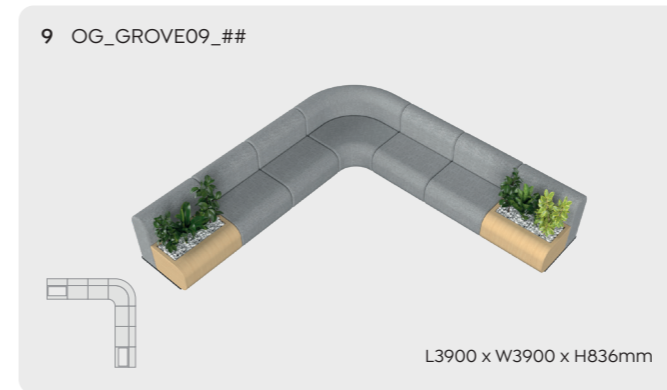
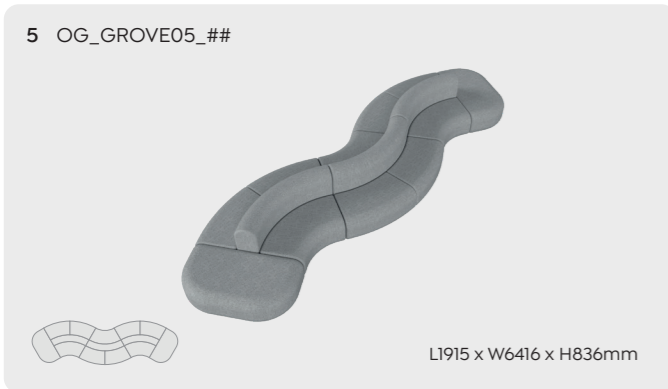

Custom Upholstery

Tailored Design. Seamless Integration.
Locally Delivered.

Introducing Blue Ink Group's new in-house upholstery capability bringing greater customisation, and premium results for your next project. Whether you're looking to add a personal touch or meet specific needs, Blue Ink Group now offers custom upholstery across a wide selection of our seating solutions.

Choose from our curated Sunday Fabric Range or supply a fabric of your choice to create truly bespoke furniture pieces. This service is available across a growing list of products, including Grove Sofa, Task chairs and select pieces within the soft seating collection.

Our Australian-based upholstery team brings decades of industry experience to every project, combining expert craftsmanship with innovation and efficiency. Backed by our Customer Partnership Managers, from pricing to delivery.

Blue Ink Group Upholstery Service offer:

- Access to Blue Ink Group's Sunday Fabric Range or customer-supplied material.s
- Customised solutions across key product lines.
- Locally managed production for improved lead times.
- Expert support from our national Customer Partnership Team.
- Backed by the quality and durability you expect from Blue Ink Group.
- Designed your way. Crafted by Blue Ink Group.





colours

Colour Guide

Looking for on brand colour fabric or bespoke options tailored to your requirements?



Choose from Blue Ink Group's on-hand stocked and styled premium range of Sunday and VICO fabrics, or supply your fabric of choice to bring your vision to life. With an Abrasion Resistance: >100,000 Martindale cycles (AS 2001.2.25), our Sunday and VICO fabric is tested to ensure durable, refined commercial-grade performance.

Sunday Fabrics

- | | | | | | | | | | | |
|----------------|-----------------|---------------|---------------|--------------------|-----------------|----------------|----------------|------------------|----------------|--------------------|
| 038
Black | 071
Charcoal | 035
Pewter | 034
Onyx | 032
Silver Grey | 204
Greymist | 039
Silver | 046
Lime | 053
Steelblue | 021
Demin | 022
Niagara |
| 024
Peacock | 050
Eggblue | 052
Mint | 045
Leaf | 158
Kellygreen | 080
Palm | 042
Citrine | 015
Apricot | 083
Ochre | 150
Caramel | 149
Fennel Seed |
| 066
Rust | 057
Dark Red | 010
Musk | 029
Bronze | 027
Walnut | 004
Mushroom | 022
Natural | 041
Ecu | | | |

VICO Fabrics - Exclusively for Avalon Sofa Series

- | | | | |
|-------------------|-----------------------|-------------------|-------------------|
| 023
Dusty Grey | 024
Ash Stone Grey | 039
Sage Green | 020
Ocean Blue |
|-------------------|-----------------------|-------------------|-------------------|

PU Leather

- | | | | | | |
|------------------|------------|--------------|-------------------|-------------------|-------------|
| CHPU
Charcoal | TPU
Tan | BPU
Black | RPU
Russet Tan | GPU
Light Grey | NPU
Navy |
|------------------|------------|--------------|-------------------|-------------------|-------------|

Powdercoat

- | | |
|------------|------------|
| B
Black | W
White |
|------------|------------|

Wood

- | | |
|------------|-----------------|
| WD
Wood | WW
Wood Wrap |
|------------|-----------------|

If you're interested in a wider variety of fabric options, contact your Blue Ink Group Customer Partnership Manager today or visit blueinkgroup.com.au

Colours are shown as accurately as possible for digital and print but may differ from the actual. Use as a guide only.

Longevity

Blue Ink Group Commitment to Quality & Longevity.

At Blue Ink Group, our design-led approach combines expert craftsmanship with conscious, considered choices to deliver a collection that's as enduring as it is inspiring.

Curated in collaboration with industry-leading designers and influenced by global colour trends, every piece is tailored to suit the evolving needs of Australian workspaces. Each item in the collection is selected not just for aesthetics, but for its ability to support healthier, more thoughtful commercial environments.

Built with longevity, and style at its core, this collection is a testament to Blue Ink Group's commitment to creating spaces that work better and last longer.



Explore, Specify, Inspire.

We'd love to partner with you to create inspirational spaces. Contact your Customer Partnership Manager or visit blueink.com.au to view the full range. Seeing is believing, book a showroom visit to view our range for yourself.

Design for Today, Built for Tomorrow.

Let Blue Ink Group's Soft Seating elevate your next interior project. Whether you're designing a high-impact reception area, a breakout nook, or a collaborative work zone, our range provides the tools to build spaces that inspire and endure.

blueink



176-178 Gladstone Street Fyshwick ACT 2609 Australia

Canberra: (02) 6166 6000 Sydney: (02) 9308 6006

Email: sales@blueinkgroup.com.au

www.blueinkgroup.com.au

Style.
Ingenuity.
Functionality.