

**blueink**



## **Seating Range**

Aspirational Design Meets Functional Solutions



# Contents

- Office Seating Solutions.....06
- Education Seating Solutions.....12
- Adapta .....16
- Avalon .....18
- Balance.....20
- Cedar .....24
- Elaro.....26
- Engage.....28
- Evo .....30
- Flow .....32
- Game.....34
- Grove Sofa .....36
- Logic.....40
- Madison.....42
- Mesa .....44
- Metro.....46
- Mode.....48
- Motion Sync .....50
- Nico .....52
- Optic .....54
- Scroll.....56
- Sofia .....58
- Stax .....62
- Tilly .....64
- Urban Mesh.....66
- Vista .....68
- Willow Lounge.....72
- Zipp.....76
- Colour Guide.....78

# Seating that works as hard as you do

From task chairs to soft seating, Blue Ink Group offers a wide range of solutions for every setting. Combining comfort, ergonomics, and uncompromising quality, our seating is built to last with durable design and timeless style. Certified to the highest standards and backed by a 10-year warranty, Blue Ink Group seating is where performance meets peace of mind.



A Vista Barstool

B Axis Trestle - Bar Table

C AcoustIQ - V-Line

D AcoustIQ - Unique Printed Panels

# Office Seating Solutions

## Categories

### Task Chairs



**Balance Project**  
Page 21



**Urban Mesh**  
Page 67



**Motion Sync**  
Page 51



**Balance Task**  
Page 22



**Tilly**  
Page 65



**Optic**  
Page 55



**Engage**  
Page 29



**Flow**  
Page 33



**Evo**  
Page 31

### Executive / Boardroom Chairs



**Mode High Back**  
Page 49



**Mode Mid Back**  
Page 49



**Mode Cantilever**  
Page 49



**Metro Mid Back**  
Page 47



**Metro Cantilever**  
Page 47



**Scroll**  
Page 57



**Nico High Back**  
Page 53



**Nico Mid Back**  
Page 53



**Balance Project**  
Page 21



**Balance Executive**  
Page 23



**Vista Swivel**  
Page 71

### Training Room Chairs



**Adapta**  
Page 16



**Logic**  
Page 40



**Balance Cantilever**  
Page 23

## Categories

### Visitor / Breakout Chairs



**Sofia Sled**  
Page 60



**Sofia Gas Lift**  
Page 60



**Sofia Gas Lift with Tilt**  
Page 61



**Balance Cantilever**  
Page 23



**Balance Visitor**  
Page 22



**Stax**  
Page 63



**Zipp**  
Page 77



**Game 4-Leg**  
Page 35



**Game Sled**  
Page 35



**Vista Pivot**  
Page 69



**Vista Tub**  
Page 70



**Vista Glide**  
Page 71



**Mesa**  
Page 45



**Elaro Armchair**  
Page 27



**Elaro Lounge**  
Page 27



**Madison**  
Page 43



**Avalon Armchair**  
Page 19



**Cedar Armchair**  
Page 25

### Barstools



**Vista Barstool**  
Page 70



**Game Barstool**  
Page 35



**Sofia Barstool**  
Page 61

# Office Seating Solutions

Categories

Soft Seating Lounges



Madison 2-Seater  
Page 43



Cedar 2-Seater  
Page 25



Cedar 3-Seater  
Page 25



Avalon 2-Seater  
Page 19



Avalon 3-Seater  
Page 19



Willow Modular Lounge  
Page 72-75



Grove Sofa  
Page 36-39



- A Elaro Lounge - Woodbase & Steelblue Upholstery
- B Cedar 2 - Seater with Tan Upholstery
- C Disc Table
- D Avalon 2- Seater with Ocean Blue Upholstery
- E Avalon Armchair with Sage Green Upholstery

# Education Seating Solutions

## Categories

### Auditorium Chairs



**Stax**  
Page 63



**Vista Glide**  
Page 71



**Game 4-Leg**  
Page 35



**Game Sled**  
Page 35



**Zipp**  
Page 77



**Adapta**  
Page 17



**Logic**  
Page 41

### Training Chairs



**Adapta**  
Page 17



**Balance Visitor**  
Page 22



**Stax**  
Page 63



**Logic**  
Page 41



**Zipp**  
Page 77



**Balance Cantilever**  
Page 23

### Lab / High Workstation Chairs



**Vista Barstool**  
Page 70



**Game Barstool**  
Page 35



**Sofia Barstool**  
Page 61

## Categories

### Admin Chairs



**Balance Project**  
Page 21



**Urban Mesh**  
Page 67



**Motion Sync**  
Page 51



**Balance Task**  
Page 22



**Tilly**  
Page 65



**Flow**  
Page 33



**Optic**  
Page 55



**Evo**  
Page 31

### Cafeteria Chairs



**Game 4-Leg**  
Page 35



**Game Sled**  
Page 35



**Stax**  
Page 63



**Vista Glide**  
Page 71



**Zipp**  
Page 77



**Vista Barstool**  
Page 70



**Game Barstool**  
Page 35

# Education Seating Solutions

## Categories

### Reception Chairs



**Stax**  
Page 63



**Zipp**  
Page 77



**Game 4-Leg**  
Page 35



**Game Sled**  
Page 35



**Vista Pivot**  
Page 69



**Vista Tub**  
Page 70



**Vista Glide**  
Page 71



**Mesa**  
Page 45



**Elaro Armchair**  
Page 27



**Elaro Lounge**  
Page 27



**Madison**  
Page 43



**Avalon Armchair**  
Page 19



**Cedar Armchair**  
Page 27



**Willow Modular Lounge**  
Page 72-75



**A** Plantation Coffee Table - 4 Leg

**B** Vista Tub with Niagara Upholstery

**C** Willow Modular Lounge

# Shaping Tomorrow's Workspaces

At Blue Ink Group, we are your partner in crafting the building blocks of future workspaces that spark productivity, creativity and well-being. This product brochure is a tool that will support you shape inspiring workspaces.



**A** Rover® Range - Mobile Whiteboard

**B** Rover® Range - Mobile TV

**C** Anvil - Single Sided Desk

**D** Rover® Range - Mobile Credenza + Planter

**E** Vista Sled

**F** Rover® Range - Glide Locker + Planter

**G** Rover® Range - Mobile Bookcase + Planter

**H** Rover® Range - Mobile Planter



# Adapta

Product Range



# Adapta

## Versatile Seating for Inspired Learning.

Designed with versatility in mind, the Adapta chair offers a space-efficient solution ideal for the educational sector.

Its design focuses on adaptability and comfort, featuring a flexible, perforated backrest and a mechanism that adjusts tilt tension to your weight, ensuring personalised support. The chair's ease of mobility is enhanced by castors on each leg, and its folding seat allows for efficient nesting and storage, making it perfect for classrooms where space is at a premium. With options for a black powder coat or chrome finish and the addition of a removable tablet arm, the Adapta chair is a practical, versatile seating choice for any educational setting.



## Features

### Versatile Design:

Ideal for education settings, collaborative workspaces, and conference rooms, adapting easily to various needs.

### Smooth Mobility:

Equipped with Castors for easy movement, perfect for dynamic classroom or training setups.

### Ergonomic Comfort:

Perforated backrest with a full 15° back recline and high-resistance moulded foam seat offer support for maximum comfort during long conferences.

### Durable Frame Options:

Black or chrome frame; removable arms, A3 tablet arm, and optional underseat basket.

### Space-Saving Nesting:

Fold-up seat for easy storage.

## Dimensions

	Seat	Overall
Width	520mm	690mm
Depth	425mm	630mm
Height	480mm	845mm

## Colours On-Hand

### Stocked & Styled



Black Base & Black Breathe Fabric Seat



Chrome Base & Black Breathe Fabric Seat





# Avalon

Product Range

# Avalon



**A timeless solution designed with flexibility at its core.**

Each piece can be used independently or combined to create a unified, inviting space. Available in armchair, two-seater, and three-seater configurations, the Avalon provides maximum adaptability for reception areas, breakout zones, and collaborative lounges that balance aesthetics and functionality.



Armchair

2-Seater

3-Seater

## Features

### Consistent Visual Language:

Clean lines, bold upholstery, and sleek frames ensure a cohesive, professional look in any setting, easily adapts to suit different projects and spatial needs.

### Configuration Options:

Choose from an individual armchair, two-seater, or three-seater. Designed to function beautifully as standalone pieces or in grouped arrangements.

### Commercial Durability:

Engineered for high-traffic environments with a robust frame and commercial-grade materials.

### Ergonomic Contours:

Designed with integrated armrests and ergonomic contours.

### Upholstery Options:

OTE VICO fabric in Ash stone Grey, Dusty Grey, Sage Green, Ocean Blue.

## Colours On-Hand

Stocked and Styled OTE VICO Fabrics



Metal Base

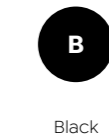

## Dimensions

	Armchair	2-Seater	3-Seater
Width	750 mm	1500 mm	1900 mm
Depth	750 mm	750 mm	750 mm
Height	775 mm	775 mm	775 mm
Seat Height	460 mm	460 mm	460 mm





# Balance

Product Range

# Balance



Task      Visitor      Executive      Cantilever      Project

## Colours On-Hand

### Stocked & Styled



Black Base & Black Breathe Fabric Seat

Only for Executive



Chrome Base & Black Breathe Fabric Seat

## Balance Project

### Features

**Invisible Lumbar Support:** Integrated lumbar within the moulded back delivers superior comfort.

**Seat Slide Adjustment:** Five-position seat slide optimises leg positioning enhancing circulation and comfort.

**Ergonomic Excellence:** Adjustable arms, adaptive lumbar, and high-density contoured foam seat offer lasting comfort.

**Breathable Comfort:** Mesh back maintains airflow, keeping users cool during extended use.

### Dimensions

	Seat	Overall
Width	495mm	710mm
Depth	485mm	710mm
Height	445-560mm	990-1100mm

## The Best in Mesh.

Discover the perfect mix of functional design and comfort with the Balance Seating Range.

Designed to cater to a variety of usages and industries, this range seamlessly blends the sleekness of mesh design with all-day comfort.

From the robust Task chair to the refined Executive, and the versatile Visitor and Cantilever chairs designed for Healthcare and Education settings, the Balance range offers a dependable solution for your Office, Education, and Healthcare seating needs.



# Balance

## Balance Task

Colour Guide on page 21

### Features

**Complementary Design:**

Matches Balance Executive for a cohesive look in workspaces that use both operator and executive seating.

**Comfortable Seating:**

High-resistance foam seat in durable Breathe fabric with a tidy under-seat finish; black nylon star base with 60mm castors ensures smooth mobility.

**Ergonomic Mesh Back:**

High-quality black mesh offers breathable support for comfortable posture.

**Personalised Adjustments:**

Lever controls seat height, tilt, and tension.

### Dimensions

	Seating	Overall
Width	505mm	720mm
Depth	510mm	700mm
Height	430-530mm	880-975mm



## Balance Visitor

Colour Guide on page 21

### Features

**Ergonomic Mesh Back:**

Breathable mesh backrest, with a full 15° back recline to enhance comfort for extended seating, ideal for meeting rooms and training areas.

**Optional Features:**

Available with removable armrests, an optional A3 tablet arm, and an optional chrome basket for under-seat storage.

**Versatile Design:**

Suitable for various settings, offering flexibility and comfort in professional spaces.

**Durable Black Frame:**

Sturdy build for high-traffic use; equipped with Castors for easy movement.

**Space-Saving Nesting:**

Fold-up seat for efficient storage.

### Dimensions

	Seating	Overall
Width	440mm	560mm
Depth	435mm	650mm
Height	475mm	870mm



# Balance

## Balance Executive

Colour Guide on page 21

### Features

**Invisible Lumbar Support:**

Integrated lumbar within the moulded back delivers superior comfort.

**Seat Slide Adjustment:**

Five-position seat slide optimises leg positioning enhancing circulation and comfort.

**Ergonomic Excellence:**

Adjustable arms, adaptive lumbar, and high-density contoured foam seat offer lasting comfort.

**Breathable Comfort:**

Mesh back maintains airflow, keeping users cool during extended use.

### Dimensions

	Seating	Overall
Width	480mm	700mm
Depth	480mm	690mm
Height	445-555mm	985-1095mm

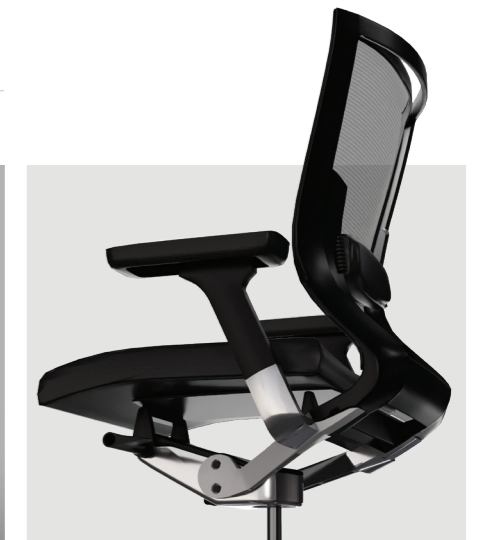
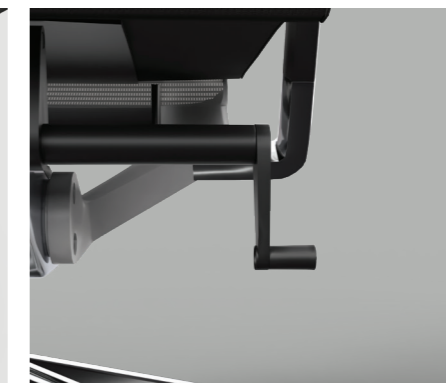

## Balance Cantilever

Colour Guide on page 21

### Features

**Invisible Lumbar Support:**

Integrated lumbar within the moulded back delivers superior comfort.

**Seat Slide Adjustment:**

Five-position seat slide optimises leg positioning enhancing circulation and comfort.

**Ergonomic Excellence:**

Adjustable arms, adaptive lumbar, and high-density contoured foam seat offer lasting comfort.

**Breathable Comfort:**

Mesh back maintains airflow, keeping users cool during extended use.

### Dimensions

	Seating	Overall
Width	470mm	470mm
Depth	460mm	460mm
Height	440mm	840mm





# Cedar



## Classic comfort with a modern twist.

Classic comfort with a modern twist. Designed for today's high-traffic, public-facing environments, Cedar features clean lines, tailored upholstery, and durable PU finishes that are easy to maintain and built to last.

Available in one, two and three-seater configurations, Cedar adapts effortlessly to a range of commercial settings, from corporate receptions and hospitality lounges to client waiting areas.

Whether used individually or arranged as a cohesive set, Cedar provides a refined, professional presence in any space.

# Cedar

Product Range



Armchair



2-Seater



3-Seater

## Features

### Durable PU Upholstery:

Easy to clean and maintain—ideal for high-use environments such as reception areas, lobbies, and public zones.

### Contemporary Frame Finish:

Black metal base with stainless steel accents and angled legs adds subtle elegance and strength.

### Flexible Modular Design:

Available in single, two and three-seater options to suit a variety of settings.

### Stylish Colour Options:

Choose from Charcoal PU or Tan PU to complement a variety of interior palettes.

## Colours On-Hand

Stocked & Styled PU Leather



Tan



Charcoal

Metal Base



Black

## Dimensions

	Armchair	2-Seater	3-Seater
Width	860 mm	1450 mm	2070 mm
Depth	740 mm	740 mm	740 mm
Height	780 mm	780 mm	780 mm
Seat Height	430 mm	430 mm	430 mm

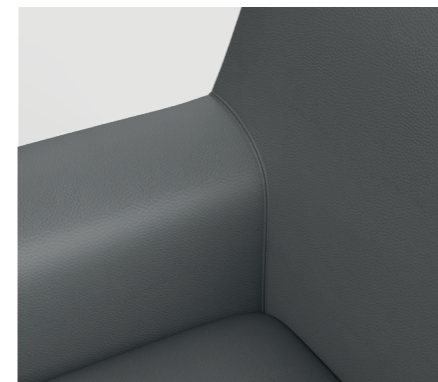



# Elaro



## Minimalist Form Meets Elegant Comfort.

A perfect fusion of contemporary design with soft curves and minimalist form, the Elaro blends elegance with functionality for today's contemporary workspaces.

Together, the Elaro Lounge and Armchair create a cohesive, modern seating pairing, ideal for reception areas, breakout zones, and collaborative environments.

# Elaro

Product Range



Elaro Armchair

Elaro Lounge

### Features Armchair

**Compact Profile:**  
Ideal for smaller spaces, offering a flexible and stylish solution.

**Crafted for Comfort:**  
Ideal for fostering a warm, inviting atmosphere in any professional setting.

**Wraparound Backrest:**  
Experience superior comfort with the wraparound backrest and contoured arms.

**Tailored for Flexibility:**  
Perfect for dining areas, collaborative spaces, or casual meeting zones.

### Features Lounge

**Top-Tier Posture Support:**  
Supportive high-back with a gentle recline, providing exceptional comfort.

**Ergonomic Contours:**  
Designed with integrated armrests and ergonomic contours.

**Exclusive Upholstery:**  
Experience the luxurious feel of premium Sunday fabric.

**Designed for Versatility:**  
Ideal for creating a welcoming atmosphere in any professional space.

### Colours On-Hand

Stocked & Styled Fabric



Base Options

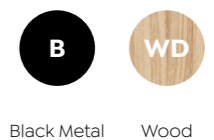

### Dimensions

Armchair	Wooden	Metal	Lounge	Wooden	Metal
Width	635 mm	635 mm	Width	770 mm	775 mm
Depth	640 mm	650 mm	Depth	770 mm	770 mm
Height	860 mm	830 mm	Height	950 mm	940 mm
Seat Height	470 mm	460 mm	Seat Height	460 mm	410 mm





# Engage

## Bold Design, Smart Comfort.

The Engage chair combines bold design with advanced ergonomic features, making it a refined choice for modern offices. Its sharp lines and premium stitching create a sophisticated aesthetic, while the adjustable padded lumbar support ensures personalised comfort.

A weight-activated mechanism adapts recline tension to the user, and the thick 60mm seat cushion provides lasting support for long working hours. With 4-way adjustable armrests offering precise ergonomic positioning, the Engage chair is designed to enhance both style and functionality in dynamic workspaces.

# Engage

Product Range



## Features

### Bold Design:

Sharp lines and premium stitching create a strong, refined aesthetic for modern offices.

### Adjustable Padded Lumbar:

Customisable lumbar support enhances comfort.

### 4-Way Adjustable Armrests:

Armrests can be adjusted in four directions with three pivot axes and height adjustment, ensuring precise ergonomic support.

### 60mm Seat Cushion:

Thick commercial grade PU seat and back padding for lasting comfort during long working hours.

### Weight-Activated Mechanism:

Recline tension adapts to user weight.

### Certifications:

Our Engage Chair comes with an AFRDI Certification.



## Dimensions

	Seat	Overall
Width	480mm	685mm
Depth	430mm	685mm
Height	465-560mm	1000-1095mm

## Colours On-Hand

Stocked & Styled



Black



Light Grey





# Evo

## Essential Comfort, Surprising Value.

Designed for affordability and functionality, the Evo features 3-lever adjustability for independent seat tilt, back tilt, and height adjustment, ensuring personalised comfort for any user. Height-adjustable armrests provide additional support, making it a versatile choice for various office environments.

AFRDI Level 6 certified and built to withstand 24-hour use, the Evo chair is both durable and reliable. With a 140kg weight rating and backed by a 10-year warranty, it's an ideal option for those seeking value and performance in a seating solution.



### Features

**Affordable Operator Option:**  
Our most budget-friendly chair, delivering essential support at a competitive price.

**AFRDI Level 6 Certified:**  
Built to meet high durability standards, suitable for 24-hour office use.

**3-Lever Adjustability:**  
Independent seat tilt, back tilt, and height adjustment for ergonomic comfort.

**Durable Comfort:**  
High-density foam ensures support and comfort for daily tasks.

**Height-Adjustable Armrests:**  
Adjustable armrests for added user support.

### Dimensions

	Seat	Overall
Width	530mm	640mm
Depth	500mm	500mm
Height	432-525mm	765-935mm

### Colours On-Hand

Stocked & Styled



Black Base & Black PU Leather





# Flow

Product Range



# Flow

## Discover the Flow.

The Flow chair brings elegance and comfort to the modern workspace with its soft, curved design and seamless aesthetics. Integrated lumbar support provides steady back support, while the weight-activated mechanism ensures ergonomic recline, adapting effortlessly to the user.

Featuring a 70mm plush foam seat for all-day comfort and 4-way adjustable armrests for personalised positioning, the Flow chair is as functional as it is refined. Built with a robust 160kg weight rating and backed by a 10-year warranty, it offers lasting quality and peace of mind for any workspace.



## Features

### Soft Design:

Smooth, curved edges and seamless aesthetics add elegance to any workspace.

### 70mm Plush Seat Foam:

Extra-thick seat cushioning offers a plush feel, ideal for all-day comfort.

### 4-Way Adjustable Armrests:

Armrests adjust in four directions with three pivot axes and height adjustment, providing personalised support.

### Weight-Activated Mechanism:

Recline adapts to user weight for ergonomic movement.

### Fixed Lumbar Support:

Integrated lumbar provides steady support.

## Dimensions

	Seat	Overall
Width	485mm	670mm
Depth	450mm	550mm
Height	455-540mm	1015-1110mm

## Colours On-Hand

Stocked & Styled



Black

Light Grey





# Game

## Smart Seating for the Classroom.

The Game Chair, designed for efficiency and mobility. With its versatile low and high profile frame options and ergonomically shaped seat and back, this chair is built to save space while providing comfort.

Its unique feet serve a dual purpose, able to connect to easily link multiple chairs, enhancing its portability.

The Game Chair's contemporary color palette ensures it fits seamlessly into a variety of settings. Ideal for training sessions, classrooms, Lab and High Workstation, and cafeterias, the Game Chair is a versatile solution for accommodating large groups.

# Game

Product Range



Barstool



4-Leg



Sled

## Features

**Flexible Upholstery Options:**  
Polypropylene shell or upholstered seat/back.

**Versatile Design:**  
Practical for training rooms, labs, and cafeterias.

**Flick-Out Name/Numbering Tab:**  
Features a retractable tab for easy labelling or numbering.

**Durable Frame Finishes:**  
Choose from powder coat options in black, white, or silver, or opt for a chrome-plated frame to suit various interiors.

**Ergonomic Comfort:**  
Contoured back moulding offers extended support.

**Colour Options:**  
Leg colours available in Black or Grey to suit various interiors.

## Dimensions

Variants	Seat	Overall
Sled	W440 x D480 x H470mm	W510 x D562 x H820mm
4-Leg	W440 x D480 x H470mm	W510 x D562 x H820mm
Barstool	W440 x D480 x H750mm	W529 x D608 x H1085mm

## Colours On-Hand

**Stocked & Styled Breathe Fabric**  
(Applies to white & charcoal shells only)



## Shell Options



## Tailored for your space.

Our upholstery service allows you to customise with confidence. Select from our curated Sunday Fabric collection or supply your fabric of choice for a seamless design match.

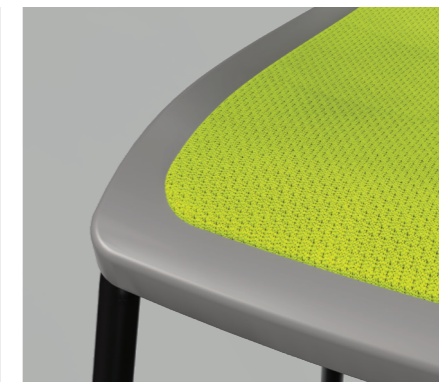
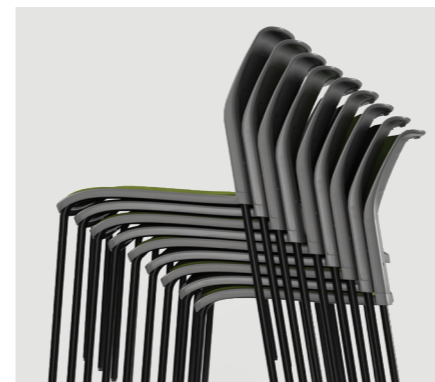
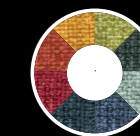



# Grove Sofa



## Transform Your Workspace.

The Grove Sofa offers a modern, modular approach to commercial seating, suitable for contemporary commercial spaces.

Featuring soft curves and edges, it incorporates biophilic elements to create a visually appealing and inviting atmosphere. The system has matching plywood modular tables and planters, enabling natural wood accents to enhance visual appeal.

Built for durability, the Grove Range uses heavy-duty commercial fabric suitable for 24-hour use, ensuring long-lasting performance and comfort. With 90° and 60° corners, this sofa system accommodates various plan layouts, providing flexibility for any environment. Available in both double-sided and single-sided configurations.

The Grove Sofa combines style, functionality, and durability, making it an ideal choice for dynamic commercial spaces.

# Grove Sofa

Product Range



## Features

### Modern Modular Design:

A sleek, modular design, perfect for enhancing contemporary commercial spaces with flexibility and style.

### Soft Curves and Edges:

Grove's soft curves reflect a modern design, enhancing contemporary office aesthetics with a soft look.

### Modular Tables & Planters:

Featuring built-in plywood planters and tables, adding functionality and natural accents to modern office spaces.

### Commercial Upholstery:

The Grove uses heavy-duty commercial fabric designed for 24-hour use, ensuring durability and long-lasting comfort.

### Configuration Options:

Available in double-sided and single-sided configurations. Accommodates various plan layouts for flexibility to fit any space.

## Colours On-Hand

### Stocked & Styled Fabrics



















Spotted Grey Wool



Ash Grey











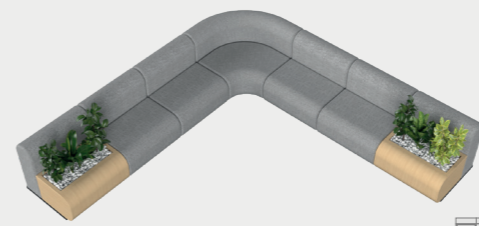

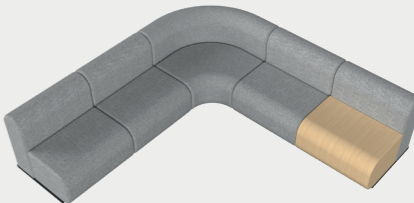

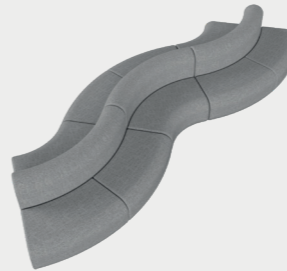
## Configurations

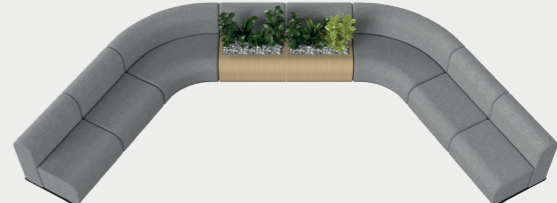
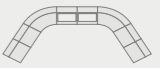
<p>1</p>  <p>OG_GROVE01_##</p> <p>L2500 x W1500 x H836mm</p> 	<p>2</p>  <p>OG_GROVE02_##</p> <p>L3400 x W1500 x H836mm</p> 
<p>3</p>  <p>OG_GROVE03_##</p> <p>L4450 x W2250 x H836mm</p> 	<p>4</p>  <p>OG_GROVE04_##</p> <p>L7980 x W2366 x H836mm</p> 
<p>5</p>  <p>OG_GROVE05_##</p> <p>L1915 x W6416 x H836mm</p> 	<p>6</p>  <p>OG_GROVE06_##</p> <p>L270 x W900 x H836mm</p> 
<p>7</p>  <p>OG_GROVE07_##</p> <p>L900 x W4500 x H836mm</p> 	<p>8</p>  <p>OG_GROVE08_##</p> <p>L8258 x W4500 x H836mm</p> 

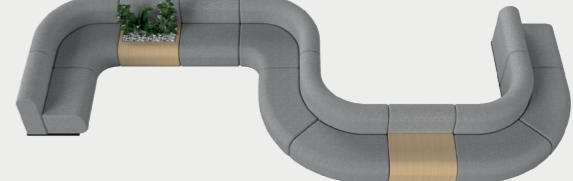
## = AG - Ash Grey  
 ## = WG - Wool Grey White  
 ## = CUSTOM - Fabric of your choice

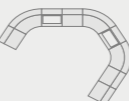
## Configurations

<p>9</p>  <p>OG_GROVE09_##</p> <p>L3900 x W3900 x H836mm</p> 	<p>10</p>  <p>OG_GROVE10_##</p> <p>L3000 x W3000 x H836mm</p> 
<p>11</p>  <p>OG_GROVE11_##</p> <p>L5400 x W1915 x H836mm</p> 	<p>12</p>  <p>OG_GROVE12_##</p> <p>L6550 x W2860 x H836mm</p> 
<p>13</p>  <p>OG_GROVE13_##</p> <p>L4200 x W3000 x H836mm</p> 	<p>14</p>  <p>OG_GROVE14_##</p> <p>L7800 x W3000 x H836mm</p> 
<p>15</p>  <p>OG_GROVE15_##</p> <p>L5872 x W3000 x H836mm</p> 	<p>16</p>  <p>OG_GROVE16_##</p> <p>L8258 x W4600 x H836mm</p> 

### Tailored for your space.

Our upholstery service allows you to customise with confidence. Select from our curated Sunday Fabric collection or supply your fabric of choice for a seamless design match.





# Logic



## Smart Seating for Learning Success.

Finally, a great looking conference & training chair that is robust, comfortable and offers a wide variety of practical features.

The Logic training chair is ideal for training rooms, conferences, education facilities and healthcare centres.

With a reclining, breathable mesh backrest and 60mm heavy-duty castors, the Logic chair can be upgraded to feature flip-up arms and an A4 fold-away table for your tablet to assist with note taking; this is a perfect choice for learning applications. And did you notice it nests and stacks to save space? That makes it an ideal choice for any high grade, mass seating situations from education to conferences to waiting areas.

# Logic

Product Range



## Features

### 15° Recline Pivot Back:

Ergonomic support with mesh back.

### Smooth Mobility:

60mm Castors for easy movement

### Stackable Feature:

Uniquely designed to be stackable, a rare quality in training chairs, making it ideal for flexible use in multi-purpose spaces.

### Optional Features:

Available with flip-up arms and an A4 fold-away tablet for additional functionality.

### Space-Saving Design:

Flip-up seat allows nesting, conserving up to 75% storage.

## Dimensions

	Seat	Overall
Width	480mm	600-620mm
Depth	430mm	590mm
Height	465mm	880mm

## Colours On-Hand

Stocked & Styled



Black Base & Black Fabric Seat





# Madison

Product Range

# Madison



## Classic Simplicity, Crafted for Every Space.

Effortlessly blending timeless design with everyday functionality, the Madison range features clean lines, smooth finishes, and comfortable form. The Madison is designed to complement both professional and casual spaces alike—whether it's a bustling office lobby or breakout space.

Available in 1-seater and 2-seater options and crafted with a solid wooden frame and premium Charcoal PU upholstery, the Madison balances durability with a polished aesthetic. Designed for both comfort and functionality, it's the perfect solution for spaces where people gather, work, or unwind.



1-Seater Madison



2-Seater Madison

## Features

### Sturdy Wooden Frame:

Built to last, the solid wooden frame ensures durability and stability, providing reliable support for years of use.

### Effortless Comfort:

Designed with comfort in mind, the Madison range is perfect for long hours of relaxation or productive conversations in lounges, lobbies, or reception areas.

### Space-Saving Nesting:

Soft, smooth, and easy to maintain, the Charcoal PU leather upholstery offers a clean and professional look with minimal upkeep.

### Simple and Versatile Design:

Its clean, straightforward design makes Madison a versatile choice, seamlessly fitting into a variety of spaces.

## Dimensions

	1-Seater	2-Seater
Overall Width	730mm	1400mm
Overall Depth	710mm	710mm
Overall Height	780mm	780mm
Seat Depth	520mm	520mm
Seat Height	440mm	440mm

## Colour On-Hand

Stocked & Styled PU Leather



Charcoal





# Mesa



## Stylish, compact, and supremely comfortable.

Blending form and function, this soft seating pair offers modern comfort with a refined aesthetic. Featuring a gently curved backrest, supportive arm profile, and a choice of base finishes, from warm timber legs to sleek powder-coated steel, this chair adapts seamlessly to both casual and professional environments.

Ideal for collaborative zones, meeting rooms, or breakout spaces, the chair comes in a two-tone upholstery option, allowing for creative combinations of texture and colour.

# Mesa

Product Range



Metal Base



Wooden Base

## Features

### Grounded in Style:

Choose between a sleek black metal base for a refined, industrial look or natural timber legs for added warmth and character.

### Enhance Comfort:

Ergonomic shell with soft foam padding provides excellent support for extended sitting.

### Multi-Functional Use:

Perfect for waiting areas, informal meeting spaces, collaborative hubs, and lounge settings.

### Durable Construction:

Engineered for commercial use with robust materials and high-quality finishes.

### Designed Flexibility:

Available in two-tone upholstery, to suit many interior palettes.

## Dimensions

Armchair	Metal	Wooden
Width	660 mm	650 mm
Depth	650 mm	630 mm
Height	795 mm	800 mm
Seat Height	460 mm	470 mm

## Colours

### Stocked & Styled Two-Tone



Tan PU Leather & Sunday Walnut Fabric



Charcoal PU Leather & Sunday Greymist Fabric

### Base Options



Black



Wood

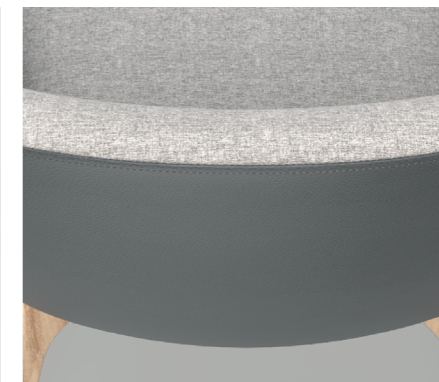



# Metro

Product Range

# Metro



## The Modern Executive.

The Metro chair combines a sleek, modern profile with exceptional durability, making it an ideal choice for executive spaces. Its stainless-steel frame and premium materials ensure reliability for daily use, while the adjustable knee-tilt mechanism and fully sprung seat base provide consistent comfort throughout the day.

With its stylish black frame option and contemporary edge, the Metro chair brings both function and aesthetic appeal to sophisticated work environments. Greenguard accredited, with a 140kg weight rating and backed by a 10-year warranty, the Metro chair is built to perform and impress.



Mid Back



High Back



Cantilever

## Features

**Enduring Comfort:**  
Adjustable knee-tilt and fully sprung seat base enhance comfort for long hours.

**Modern Profile:**  
Sleek design with a black frame option adds a contemporary edge.

**Executive Appeal:**  
High-quality construction and stylish design make it an ideal choice for executive spaces.

**Built to Last:**  
Stainless-steel frame and premium materials ensure durability for daily use.

## Colours On-Hand

Stocked & Styled PU Leather\*

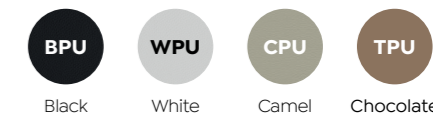

Base Options\*

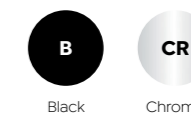

\*Mid Back - Chrome Base only available for Black & White PU Leather.

\*Cantilever - Only available in Chrome Base with Black or White PU Leather.

## Dimensions

Overall	High Back	Mid Back	Cantilever
Width	660mm	660mm	625mm
Depth	650mm	650mm	600mm
Height	960-1030mm	960-1030mm	940mm





# Mode



## The Traditional Executive

The Mode chair combines timeless design with ergonomic functionality, making it a sophisticated choice for executive and boardroom settings. Featuring a polished stainless-steel tubular frame and individually upholstered cushions, it delivers classic style and enduring quality.

The synchronised tilting mechanism supports proper posture, while safety-focused tension control adjusts smoothly to user weight, starting from a stable recline. Premium padding on the seat and back provides plush comfort for extended use.

Greenguard accredited, with a 140kg weight rating and backed by a 10-year warranty, the Mode chair is a premium solution for refined workspaces.

# Mode

Product Range



Cantilever



High Back



Mid Back

## Features

### Timeless Design:

Polished stainless-steel tubular frame with individually upholstered cushions suits a classic style.

### Safety-Focused Tension Control:

Begins at a stable recline, adjusting to user weight smoothly.

### Premium Upholstery:

Padded seat and back provide a plush, comfortable experience in executive and boardroom settings.

### Ergonomic Comfort:

Synchronized tilting mechanism supports proper posture.

### Ergonomic Comfort:

Synchronized tilting mechanism supports proper posture.

## Colours On-Hand

### Stocked & Styled PU Leather\*



### Base Options\*

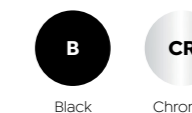

**\*High Back & Mid Back** - Chrome Base only available for Black & White PU Leather.

Chocolate PU Leather only available with Black Base

**\*Cantilever** - Available in Black PU Leather & Chrome Base only.

## Dimensions

Overall	High Back	Mid Back	Cantilever
Width	730mm	730mm	600mm
Depth	730mm	760mm	630mm
Height	1075-1150mm	895-985mm	920mm





# Motion Sync

## Ultimate Comfort.

The Motion Sync Chair combines exceptional comfort with innovative functionality, making it ideal for modern office environments. Its premium operator design features a wider seat and backrest for added comfort, while the multiple fulcrum synchro-tilt mechanism ensures smooth, synchronized movement with adaptable tension. Weight-sensitive adjustments provide natural support, and an adjustable seat slide promotes healthy circulation.

Designed for easy maintenance, the chair includes removable lumbar support and seat covers. Upholstered in high-density foam with Sunday or Motion Felt fabrics, the Motion Sync delivers ergonomic excellence and sleek style in one versatile solution.

# Motion Sync

Product Range



## Features

**Premium Operator Design:** Wider seat and backrest enhance comfort and accommodate a diverse range of users, making it a top choice for varied office environments.

**Multiple Fulcrum Synchro-Tilt:** Features a 1:2 seat-to-back tilt ratio with multiple fulcrum points for smooth, synchronized movement and adaptable tension adjustment.

**User-Friendly Maintenance:** Designed for easy assembly, with removable lumbar support and seat covers for hassle-free user installation and upkeep.

**Seat Slide:** Adjustable seat slide enhances leg positioning and circulation.

**Weight-Sensitive Tension:** Adjusts to user weight, providing natural support.

## Colours On-Hand

### Stocked & Styled Motion Felt



### Stocked & Styled Sunday Fabrics

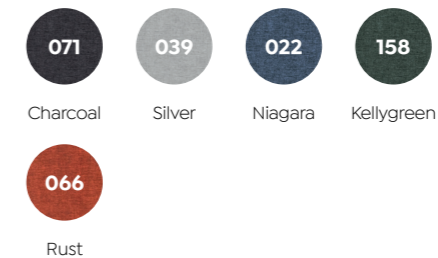

## Dimensions

	Seat	Overall
Width	465mm	625mm
Depth	485mm	660mm
Height	470-585mm	955-1070mm

## Tailored for your space.

Our upholstery service allows you to customise with confidence. Select from our curated Sunday Fabric collection or supply your fabric of choice for a seamless design match.





# Nico

Product Range



# Nico

**Crafted for Comfort. Designed for Distinction.**

The Nico Chair redefines luxury seating for the modern executive. With an innovative hidden wire control mechanism and weight-sensitive recline, the Nico adapts effortlessly to the user's body for a personalised experience. Backed by a 10-year warranty and the 2022 German Design Award, the Nico chair is more than just seating, it's a statement of superior design and enduring quality. Ideal for executive needs.



### Executive High Back

Charcoal      Grey      Tan

### Executive Mid Back

Tan      Grey      Charcoal

## Features

#### Dynamic Support System:

Adaptive split-structure backrest combines soft cushioning with flexible materials for ultimate comfort.

#### Arch Sponge Cushion:

Arched design delivers superior muscle support for unmatched seating comfort.

#### Aluminum Armrest:

Sleek aluminum armrest in black, equipped with a PU cap for added comfort.

#### Ergonomic Excellence:

Precision-engineered with German technology to support your posture effortlessly.

#### Hidden Wire Control Mechanism:

Fully concealed recline system preserves the sleek and seamless appearance.

#### Premium Upholstery:

Crafted with premium cow-hide leather insert and durable PU. Both with impeccable seam stitching for a luxurious look.

## Dimensions

	High Back	Mid Back
Seat Width	530mm	530mm
Seat Depth	450mm	450mm
Seat Height	455-505mm	455-505mm
Overall Width	630mm	630mm
Overall Depth	650mm	625mm
Overall Height	1160-1220mm	935-995mm

## Colours On-Hand

Stocked & Styled Leather and PU Leather

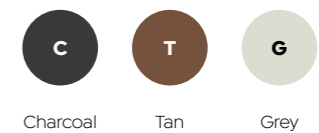



# Optic



## Engineered for Everyday Excellence.

The Optic chair delivers reliable and ergonomic support for everyday office tasks.

Featuring a breathable mesh back for comfort and simple controls for adjusting seat height and tilt, it offers customisation to suit different user needs. With a durable base and smooth 60mm castors, the Optic ensures stable mobility across various surfaces.

Built with a robust 140kg weight rating, BIFMA accreditation, and backed by a 10-year warranty, the Optic is a dependable and functional choice for standard office environments.

# Optic

Product Range



## Features

**Functional Choice:**  
Reliable, straightforward option suitable for standard office needs, offering essential comfort without added features.

**Ergonomic Support:**  
Breathable mesh back offers comfortable support during routine tasks.

**Easy Adjustability:**  
Simple controls for seat height and tilt make customisation easy for different user needs.

**Sturdy Design:**  
Durable base with 60mm castors ensures smooth mobility on various surfaces.

## Dimensions

	Seat	Overall
Width	490mm	625mm
Depth	490mm	630mm
Height	400-480mm	960-1030mm

## Colours On-Hand

Stocked & Styled



Black Base & Black Fabric Seat





# Scroll

Product Range



# Scroll

## The Trend Setter.

Whether in the office, meeting room, or executive space, Blue Ink Group's versatile Scroll chair is engineered for both comfort and a luxury aesthetic. A single piece of high-performance mesh forms the seat and backrest, while a polished alloy base provides both stability and that classic, minimalist look.

Exceptional comfort and adjustable features are the hallmark of the Scroll, with a simple lockable tilting function, wire control for height adjustment, tension adjustment for reclining, and contoured removable armrests.



## Features

### Modern Aesthetic:

Sleek, one-piece mesh design with minimalist, high-end look that complements any workspace.

### Refined Comfort:

Contoured back and seat to provide a visually lightweight, supportive feel, suitable for executive, conference, and boardroom areas.

### Customisable Style:

Available with Alloy or Nylon base options and in Grey or Black mesh.

### Focused Simplicity:

Offers essential functionality with a tension adjustable tilt and height settings.

## Dimensions

	Seat	Overall
Width	485mm	580mm
Depth	430mm	520mm
Height	440-560mm	865-965mm

## Colours On-Hand

### Stocked & Styled



Black



Grey





# Sofia

Product Range

# Sofia



Sled Gas Lift Gas Lift with Tilt Barstool

## Features

### Premium Designer Collection:

Created for breakout areas and meeting room settings, combining sophistication with enduring durability.

### Flexible Configuration:

Sled links enable seamless chair connections in conference layouts, enhancing breakout functionality.

### Versatile Fit:

Comfortably sized to suit a diverse range of users.

### Fully Upholstered Elegance:

Fine stitching and PU or exclusive Blue Ink Group Sunday fabric for a luxurious look.

## Colours On-Hand

### Stocked & Styled Sunday Fabric



### Stocked & Styled PU Leather



### Base Options



## Dimensions

Variants	Seat	Overall
Sled	W570 x D530 x H450mm	W570 x D530 x H840mm
Gas Lift	W520 x D430 x H455-520mm	W570 x D500 x H845-910mm
Gas Lift with Tilt	W520 x D430 x H455-520mm	W570 x D500 x H845-910mm
Barstool	W527 x D628 x H762mm	W527 x D635 x H1156mm

## Luxe Seating for Dynamic Environments.

Accentuate your workspace with Sofia, a meeting and a breakout chair that brings luxury and modernity to any commercial setting. Upholstered in eight stunning colours—four in premium PU Leather (Black, Russet Tan, Light Grey, Navy) and four in premium Sunday fabric by OTE (Pewter, Grey Mist, Steel Blue, Leaf) – Sofia is designed to impress.

Choose from 4 different bases (Sled, Stool, Gas Lift, Gas Lift with Tilt) in sleek black or white finishes, making it a versatile and sophisticated addition to conference rooms, training areas, meeting spaces, and waiting areas.



# Sofia

## Sofia Gas Lift

Colour Guide on page 59

### Features

**Premium Designer Collection:**

Created for breakout areas and meeting room settings, combining sophistication with enduring durability.

**Adjustable Comfort:**

Gas lift mechanism adapts to height preferences; fixed arms provide steady support.

**Versatile Fit:**

Comfortably sized to suit a diverse range of users.

**Fully Upholstered Elegance:**

Fine stitching and PU or exclusive Blue Ink Group Sunday fabric for a luxurious look.

**Fixed Arm Option:**

Comes with sturdy fixed arms, providing comfortable support without sacrificing sleek design.

### Dimensions

	Seating	Overall
Width	520mm	570mm
Depth	430mm	500mm
Height	455-520mm	845-910mm



## Sofia Sled

Colour Guide on page 59

### Features

**Premium Designer Collection:**

Created for breakout areas and meeting room settings, combining sophistication with enduring durability.

**Flexible Configuration:**

Sled links enable seamless chair connections in conference layouts, enhancing breakout functionality.

**Fully Upholstered Elegance:**

Fine stitching and PU or exclusive Blue Ink Group Sunday fabric for a luxurious look.

**Versatile Fit:**

Comfortably sized to suit a diverse range of users.

### Dimensions

	Seating	Overall
Width	570mm	570mm
Depth	530mm	500mm
Height	450mm	840mm



# Sofia

## Sofia Gas Lift with Tilt

Colour Guide on page 59

### Features

**Premium Designer Collection:**

Created for breakout areas and meeting room settings, combining sophistication with enduring durability.

**Customisable Comfort:**

Gas lift for height adjustment and tilt functionality for flexible comfort.

**Versatile Fit:**

Comfortably sized to suit a diverse range of users.

**Fully Upholstered Elegance:**

Fine stitching and PU or exclusive Blue Ink Group Sunday fabric for a luxurious look.

**Fixed Arm Option:**

Comes with sturdy fixed arms, providing comfortable support without sacrificing sleek design.

### Dimensions

	Seating	Overall
Width	520mm	570mm
Depth	430mm	500mm
Height	455-520mm	845-910mm

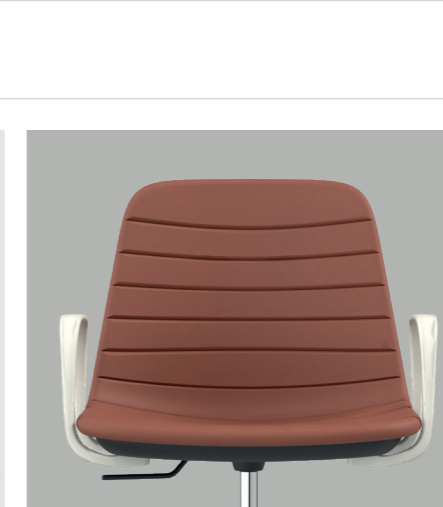
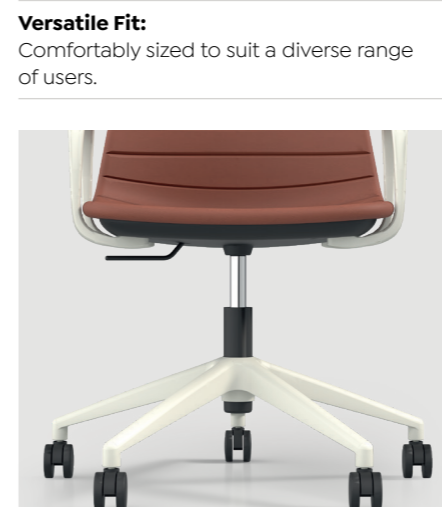

## Sofia Barstool

Colour Guide on page 59

### Features

**Premium Designer Collection:**

Created for breakout areas and meeting room settings, combining sophistication with enduring durability.

**Sleek Sled Frame:**

Features a stable sled base that complements modern interiors, ideal for high-top tables and counters in breakout areas.

**Fully Upholstered Elegance:**

Fine stitching and PU or exclusive Blue Ink Group Sunday fabric for a luxurious look.

**Versatile Fit:**

Designed with a taller profile to suit a range of users comfortably in elevated seating areas.

### Dimensions

	Seating	Overall
Width	527mm	527mm
Depth	628mm	635mm
Height	762mm	1156mm





# Stax

Product Range



# Stax

## Effortless Assembly, Enduring Comfort.

The Stax chair combines practical design with ease of assembly, requiring no tools for quick setup.

Built on a durable steel rod frame and featuring a contoured shell for ergonomic support, this chair offers both strength and comfort. Its breathable backrest and moulded polypropylene cushion provide a comfortable seating experience for any occasion.

Designed for efficient storage, the Stax chair can be stacked up to 15 chairs high with a trolley, allowing for swift clearing and setup of spaces. Ideal for use in staff rooms, cafeterias, training rooms, or breakout areas, the Stax chair is a versatile and sturdy choice for any environment.



## Features

### Affordable Style:

Modern polypropylene chair, practical for large conference spaces and events.

### Linking Capability:

Built-in linking option for organised, connected rows.

### Stackable Design:

Stacks up to 15 chairs high; compatible with Game Chair trolley.

### Quick Installation:

Fast setup makes it ideal for large gatherings.

### Perforated Back:

Enhances airflow for comfort during long sessions.

### Colour Options:

Available in Black or Grey to suit various interiors.

## Dimensions

	Seat	Overall
Width	500mm	510mm
Depth	430mm	560mm
Height	440mm	790mm

## Colours On-Hand

### Stocked & Style

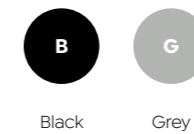

Black

Grey





# Tilly

## Affordable Comfort, Reliable Performance.

The Tilly task chair is designed for everyday comfort, featuring high-density foam cushioning and a taller backrest for lasting support. With height-adjustable arms, lumbar support, and a mesh back, it offers essential ergonomic comfort tailored to user needs.

The enhanced gas lift accommodates a variety of heights, while durable 60mm PU castors ensure smooth mobility across surfaces. BIFMA certified and built to balance quality and value, the Tilly task chair supports up to 140kg and is backed by a 10-year warranty, making it a reliable choice for functional workspaces.

### Features

**Designed for Everyday Comfort:**

High-density foam cushioning and taller backrest provide lasting support.

**Essential Ergonomics:**

Adjustable arms, lumbar support, and mesh back offer ergonomic comfort.

**Enhanced Range:**

Taller gas lift accommodates a variety of user heights.

**Balanced Quality and Value:**

Built to meet all core ergonomic needs at a competitive price, making it an ideal choice for functional workspaces.

**Smooth Mobility:**

Durable 60mm PU Castors support stable movement across surfaces, ensuring efficient daily use for extended periods.

**Certifications:**

Our Tilly Chair comes with an AFRDI Certification.



### Dimensions

	Seat	Overall
Width	505mm	675mm
Depth	475mm	610mm
Height	445-560mm	995-1115mm

### Colours On-Hand

Stocked & Styled



Black Base & Black Breathe





# Urban Mesh

## Seating Comfort, Built to Last.

The Urban Mesh chair is engineered for durability and adaptability, perfectly suited for high-usage environments.

It features three adjustable levers, allowing users to fine-tune seat height, tilt, and backrest recline to fit their body's needs. The chair is designed with a mesh backrest for breathability and a high-resistance molded foam cushion for support. Notably, it offers customisation through reupholstering in any fabric choice, alongside our standard breathable MotionFelt or black Breathe fabric options.

Optional upgrades include armrests, a gas lift, and a chrome foot ring, enhancing the Urban Mesh's functionality and comfort for any workplace setting.

# Urban Mesh

Product Range



## Features

### Trusted Performance:

AFRDI Level 6 certified, meeting the highest standards of durability and quality for operator chairs.

### All-Day Comfort:

Extra-thick foam seat offers comfortable support for 24-hour usage, perfect for busy offices.

### User-Friendly Assembly:

No-bolt design for quick setup and easy maintenance.

### 3-Lever Ergonomic Adjustability:

Three levers offer precise control over seat height, back angle, and seat tilt, allowing users to find their ideal ergonomic position.

### Modern Operator Design:

Narrow mesh back promotes airflow and arm movement.

### Certifications:

Our Urban Mesh Chair comes with an AFRDI Certification.



## Colours On-Hand

### Stocked & Styled Motion Felt



### Stocked & Styled Sunday Fabrics

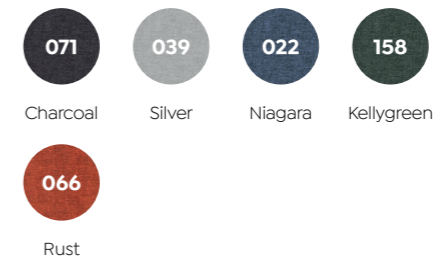

## Dimensions

	Seat	Overall
Width	520mm	580mm
Depth	470mm	550mm
Height	440-535mm	990-1100mm

## Tailored for your space.



Our upholstery service allows you to customise with confidence. Select from our curated Sunday Fabric collection or supply your fabric of choice for a seamless design match.





# Vista



## The Complete Solution.

Discover the versatile Vista seating range, now including the stylish Vista Tub. This collection offers fully upholstered options, perfect for meeting rooms, breakout areas, and conference spaces. Choose from five models: Swivel, Glide, Pivot, Rise, and the new Vista Tub, each designed to balance comfort, durability, and modern style.

The stackable Vista Glide maximises space efficiency, while Swivel and Pivot provide mobility and stability with a 140kg weight rating. Now, with the Vista Tub featuring matching Sunday fabric and Pantone base colours, the range is more versatile than ever.

Backed by a 10-year warranty, Vista offers peace of mind and lasting value.

# Vista

Product Range



## Colours On-Hand

Stocked & Styled Sunday Fabric and Base



Moss Base & Kellygreen Fabric



Sky Base & Niagara Fabric



Black Base & Charcoal Fabric



White Base & Silver Fabric



Rust Base & Rust Fabric

Unavailable for Vista Tub

Unavailable for Vista Tub

## Vista Pivot

### Features

#### Fine Detailing:

Designed with a sophisticated pivot mechanism, showcasing refined detailing that elevates any breakout space.

#### 4-Point Base:

Provides balanced support with a modern, stable foundation.

#### Premium Colour-Matched Base:

Features a colour coordinated base, adding a refined visual highlight to both standard and elevated seating.

#### Flexible Upholstery Options:

Upholstered seat and/ or back that align with the exclusive Blue Ink Group Sunday fabric range, offering a premium, tailored look.

#### One-Size-Fits-All Design:

Versatile shell comfortably accommodates a range of users.

### Dimensions

	Seating	Overall
Width	465mm	465mm
Depth	450mm	525mm
Height	450mm	825mm

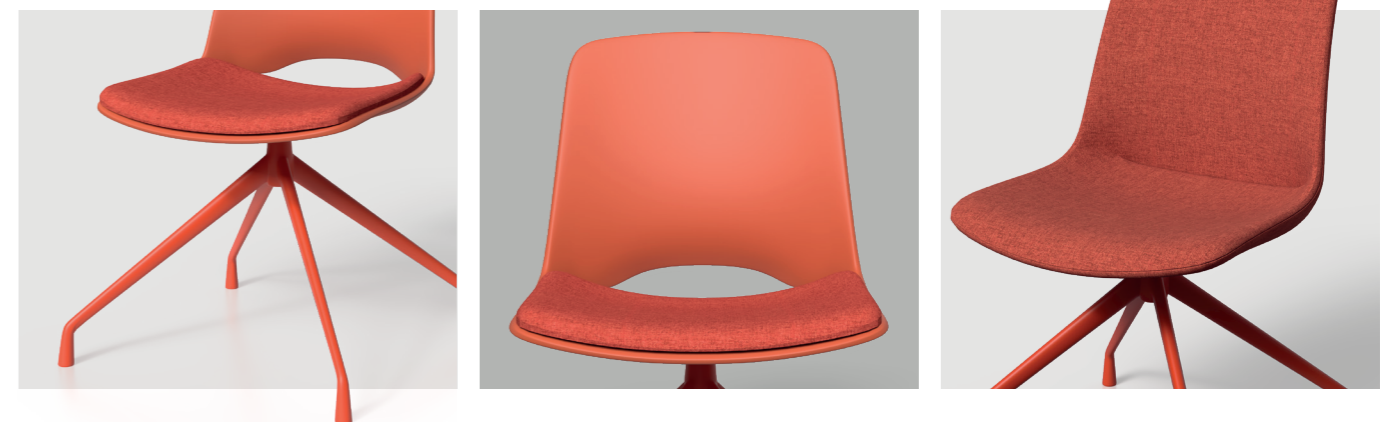

# Vista

## Vista Tub

Colour Guide on page 69

### Features

**Distinctive Tub Design:**

Unique to the Vista range, offering an inviting, enclosed seating style ideal for breakout and lounge areas.

**Premium Colour-Matched Base:**

Features a colour coordinated base, adding a refined visual highlight to both standard and elevated seating.

**Versatile Fit:**

Generous proportioned for comfort, to accommodate a wide range of users.

**Exclusive Upholstery Options:**

Available in select colours from Blue Ink Group Sunday fabric for durability and style.

### Dimensions

	Seating	Overall
Width	500mm	620mm
Depth	430mm	560mm
Height	450mm	785mm

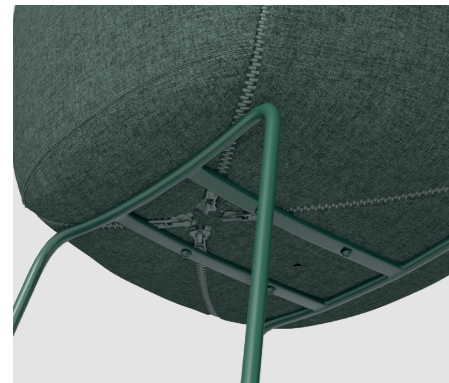

## Vista Barstool

Colour Guide on page 69

### Features

**One-Size-Fits-All Design:**

Unified shell in both sled chair and barstool heights, ideal for diverse seating needs in breakout spaces.

**Flexible Upholstery Options:**

Durable polypropylene shell. Choose from upholstered seat only or fully upholstered with Sunday Fabric.

**Premium Colour-Matched Base:**

Features a colour coordinated base, adding a refined visual highlight to both standard and elevated seating.

**Durable and Comfortable:**

High-quality materials and thoughtful design ensure lasting comfort in casual and collaborative settings.

### Dimensions

	Seating	Overall
Width	465mm	465mm
Depth	455mm	540mm
Height	730mm	1140mm

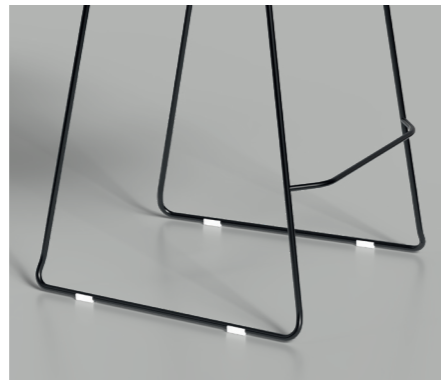

# Vista

Colour Guide on page 69

## Vista Glide



### Features

**One-Size-Fits-All Design:**

Unified shell in both Sled chair and Barstool heights, ideal for diverse seating needs in breakout spaces.

**Flexible Upholstery Options:**

Durable polypropylene shell. Durable polypropylene shell. Choose from no seat pad, seat pad with matching upholstery or fully upholstered.

**Premium Colour-Matched Base:**

Features a colour coordinated base, adding a refined visual highlight to both standard and elevated seating.

**Durable and Comfortable:**

High-quality materials and thoughtful design ensure lasting comfort in casual and collaborative settings.

### Dimensions

	Seating	Overall
Width	465mm	465mm
Depth	455mm	545mm
Height	475mm	830mm



## Vista Swivel

Colour Guide on page 69

### Features

**Practical Swivel Mechanism:**

Provides easy mobility and flexibility, ideal for breakout and collaborative spaces.

**One-Size-Fits-All Design:**

Versatile shell accommodates a wide range of users comfortably.

**Nylon Castor Base:**

Available in Black or White, providing stable movement across surfaces.

**Flexible Upholstery Options:**

Choose from upholstered seat only or fully upholstered with Sunday Fabric.

### Dimensions

	Seating	Overall
Width	465mm	595mm
Depth	455mm	530mm
Height	420-515mm	765-860mm





# Willow Lounge

Product Range

# Willow



## Willow Modular Lounge.

Adaptable modular seating for evolving spaces. Designed for flexibility, making it ideal for breakout areas, team zones and transitional areas. Willow's cohesive design language pairs seamlessly with the Willow Booth Series, enabling a coordinated, connected environment across open-plan interiors.



## Features

### Modular Configuration:

Modular configuration enables tailored layouts and future adaptability.

### Collaborative Flexibility:

Enhances collaborative settings such as breakout zones and informal workspaces.

### Enhance Comfort:

Ergonomic shell with soft foam padding, excellent support for extended sitting and high traffic areas.

### Base Alternatives:

Sturdy metal legs that may be wrapped in wood for an alternate finish.

### Durable construction:

Engineered for commercial use, robust materials and high-quality fabric.

### Adaptive Design:

Integrates visually and functionally with the Willow Booth Series for unified spatial planning.

## Colours On-Hand

### Stocked & Styled Sunday Fabric



Charcoal Onyx Niagara Kellygreen

### Base Options



Black Metal Wood Wrap

## Tailored for your space.



Our upholstery service allows you to customise with confidence. Select from our curated Sunday Fabric collection or supply your fabric of choice for a seamless design match.



## Configurations

- # = B-Black Flame
- # = O-Oak Frame
- ## = KG-Kellygreen
- ## = CH-Charcoal
- ## = NA-Niagara
- ## = CUSTOM-Your Fabric of Choice

1 OG\_WML2BENCH#\_FOX

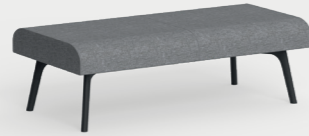

W1360 x D680 x H 430mm

2 OG\_WML2STL#\_##



W1360 x D680 x H780mm

3 OG\_WML2SOFA#\_##



W1680 x D680 x H780mm

4 OG\_WML3BENCH#\_FOX

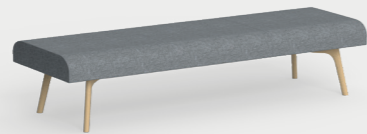

W2040 x D680 x H430mm

5 OG\_WML3STL#\_##



W2040 x D680 x H780mm

6 OG\_WML3SOFA#\_##

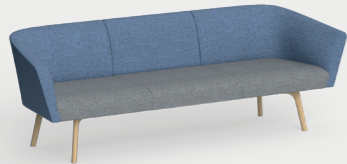

W2360 x D680 x H780mm

7 OG\_WML4STL#\_##



W2720 x D680 x H780mm

8 OG\_WMLKIT001#\_FOX##



W2880 x D680 x H780mm

9 OG\_WMLKIT002#\_FOX##

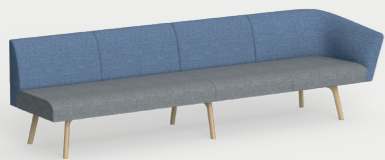

W2880 x D680 x H780mm

10 OG\_WML4SOFA#\_##



W3040 x D680 x H780mm

11 OG\_WMLKIT003#\_FOX##



W2880 x D680 x H780mm

12 OG\_WMLKIT004#\_FOX##



W2880 x D680 x H780mm

13 OG\_WMLKIT005#\_FOX##

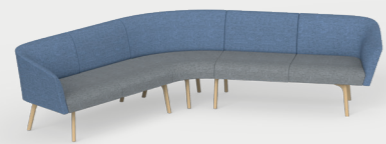

W2460 x D1530+680 x H780mm

14 OG\_WMLKIT006#\_FOX##



W2460 x D1360+680 x H780mm

## Configurations

15 OG\_WMLKIT007#\_FOX##



W2460 + D1360 + D680 H780mm

16 OG\_WMLKIT008#\_FOX##



W4760 x D680 x H780mm

17 OG\_WMLKIT009#\_FOX##



W4257 x D2193 x H780mm

18 OG\_WMLKIT010#\_FOX##



W4243 x D2880 x H780mm

19 OG\_WMLKIT012#\_FOX##



W3400 x D2720 x H780mm

20 OG\_WMLKIT011#\_FOX##



W2720 x D1360 x H780mm

21 OG\_WMLKIT013#\_FOX##



W5040 x D3198 x H780mm



# Zipp



## Seamless Comfort, Streamlined Design.

The Zipp chair combines sleek European design with exceptional functionality, making it an ideal choice for modern offices and breakout spaces. Its durable black powder-coated frame, featuring a tear-drop leg shape, supports up to 140kg, ensuring long-lasting reliability. Designed for comfort, the Zipp chair includes 40mm foam padding in the seat and back, with optional fixed arms for added support.

Available in Blue Ink Group Breathe and Sunday fabric ranges, with custom fabrics available upon request, it offers flexible upholstery options to suit any space. With a stackable design that allows up to six chairs to be stored together, the Zipp chair is perfect for flexible, multi-use areas. Greenguard and BIFMA accredited, and backed by a 10-year warranty, the Zipp chair is the versatile, stylish solution for dynamic workplaces.



Zipp Chair – Armless



Zipp Chair – With Arms



### Features

#### European Design:

Sleek, minimalist style ideal for modern offices and breakout spaces.

#### Enhanced Comfort:

40mm foam padding in seat and back for added comfort.

#### Tear-Drop Leg Shape:

Durable black powdercoated frame supports up to 140kg.

#### Flexible Upholstery Options:

Available in Blue Ink Group Breathe and Sunday fabric ranges, with custom fabrics by request.

#### Stackable Design:

Stacks up to 6 chairs high, suitable for flexible, multi-use areas.

### Dimensions

	Seat	Overall
Width	450mm	450-525mm
Depth	440mm	575mm
Height	465mm	825mm

### Colours On-Hand

#### Stocked & Styled Breathe Fabric\*



\*Zipp Chairs with arms - Only available in Black Breathe Fabric

### Tailored for your space.



Our upholstery service allows you to customise with confidence. Select from our curated Sunday Fabric collection or supply your fabric of choice for a seamless design match.



# Colour Guide

Looking for on brand colour fabrics or bespoke options tailored to your requirements?



Choose from Blue Ink Group's on hand stocked and styled range of fabrics, Splice, Breathe and premium Sunday, or supply your own to bring your vision to life.

## Sunday Fabrics

<b>038</b> Black	<b>071</b> Charcoal	<b>035</b> Pewter	<b>034</b> Onyx	<b>032</b> Silver Grey	<b>204</b> Greymist	<b>039</b> Silver	<b>046</b> Lime	<b>053</b> Steelblue	<b>021</b> Demin	<b>022</b> Niagara
<b>024</b> Peacock	<b>050</b> Eggblue	<b>052</b> Mint	<b>045</b> Leaf	<b>158</b> Kellygreen	<b>080</b> Palm	<b>042</b> Citrine	<b>015</b> Apricot	<b>083</b> Ochre	<b>150</b> Caramel	<b>149</b> Fennel Seed
<b>066</b> Rust	<b>057</b> Dark Red	<b>010</b> Musk	<b>029</b> Bronze	<b>027</b> Walnut	<b>004</b> Mushroom	<b>022</b> Natural	<b>041</b> Ecu			

## Breathe Fabrics

<b>B</b> Black	<b>SG</b> Slate Grey	<b>AG</b> Alloy Grey	<b>C</b> Camel	<b>BRO</b> Orange	<b>BUO</b> Burnt Orange	<b>TR</b> Tomato Red	<b>R</b> Ruby Red	<b>PL</b> Plum	<b>N</b> Navy	<b>ST</b> Steelblue
<b>RB</b> Royal Blue	<b>SB</b> Sky Blue	<b>BB</b> Baby Blue	<b>TR</b> Tomato Red	<b>LG</b> Lime Green	<b>FG</b> Fern Green					

## Splice Fabrics

<b>BK</b> Black	<b>CH</b> Charcoal	<b>GR</b> Grey	<b>FS</b> Fossil	<b>SC</b> Sandcastle	<b>YL</b> Yellow	<b>OR</b> Orange	<b>RD</b> Red	<b>SL</b> Salmon	<b>BL</b> Blue	<b>LA</b> Lagoon
<b>GN</b> Green										

## VICO Fabrics

Exclusively for Avalon Sofa Series

<b>023</b> Dusty Grey	<b>024</b> Ash Stone Grey	<b>039</b> Sage Green	<b>020</b> Ocean Blue
--------------------------	------------------------------	--------------------------	--------------------------

## PU Leather

<b>CHPU</b> Charcoal	<b>TPU</b> Tan	<b>BPU</b> Black	<b>RPU</b> Russet Tan	<b>GPU</b> Light Grey	<b>NPU</b> Navy
-------------------------	-------------------	---------------------	--------------------------	--------------------------	--------------------

## Motion Felt

<b>004</b> Charcoal (CL)	<b>002</b> Stone Grey (ST)	<b>041</b> Grey (AG)	<b>029</b> Ice Blue (IC)	<b>027</b> Deep Blue (DB)	<b>057</b> Emerald Green (EG)	<b>066</b> Avocado (AG)	<b>010</b> Bumblebee (BB)	<b>149</b> Sunset Orange (SO)	<b>150</b> Chili Red (CR)
-----------------------------	-------------------------------	-------------------------	-----------------------------	------------------------------	----------------------------------	----------------------------	------------------------------	----------------------------------	------------------------------

## Powdercoat

<b>B</b> Black	<b>W</b> White
-------------------	-------------------

## Wood

<b>WD</b> Wood	<b>WW</b> Wood Wrap
-------------------	------------------------

If you're interested in a wider variety of fabric options, contact your Customer Partnership Manager today or visit [blueinkgroup.com.au](http://blueinkgroup.com.au)

Colours are shown as accurately as possible for digital and print but may differ from the actual. Use as a guide only.



# Partner with us

At Blue Ink Group, we deliver on our commitment by working together to provide a solution-focused approach to meet your specific needs. We strive to be efficient in the value creation in our supply chain system and operations to produce aspirational and functional products delivered with exceptional standards.

**We believe in building enduring partnerships to achieve mutual outcomes.**

# blueink



176-178 Gladstone Street Fyshwick ACT 2609 Australia

Canberra: (02) 6166 6000 Sydney: (02) 9308 6006

Email: [sales@blueinkgroup.com.au](mailto:sales@blueinkgroup.com.au)

[www.blueinkgroup.com.au](http://www.blueinkgroup.com.au)