

Blue Ink Group Furniture Catalogue

WORKSTATIONS | SEATING | STORAGE | ACCESSORIES



Ph: 1300 680 560 | Email: sales@blueinkgroup.com.au



NEW OUTDOOR RANGES!



Proudly Australian Owned

Rapidline is a premium, commercial furniture range that has been designed and developed by the Furnx team right here in Australia.

Rapidline products are known for their strength, durability and stability, with many AFRDI certified.

Delivered to you from distribution centres across Sydney, Melbourne, Brisbane, Perth and Adelaide, with a local customer service team in each state.















Contents



CONTENTS			
Colour Chart		3	
RECEPTION			
Reception Counters		5-6	
Lounge Chairs & Ottomans		7-12	
Side Tables & Coffee Tables		13-16	
Accessories		16	
RANGES			
Deluxe Infinity		17-34	
Casa Executive		35-36	
Rapid Span		37-39	
Rapid Worker		40-44	
HALO Static		47-48	
HALO+		49-50	
HALO+ and BOOST+ Executive		51-52	
BOOST+		53-54	
BOOST Light, Crank & Static		55-57	
BOOST & HALO Accessories		58-62	
SCREENS			
SHUSH30+ Screen System		63-68	
ECO Desk Mounted Screens		69-70	
SOFTWARE & CABLE MANAGEMENT			
Softwiring & Cable Management			71-74
Monitor Arms & TV Mounts			75-76
TABLES			
Tables			77-86
SEATING			
Chairs			87-111
Upholstery			112
Outdoor Range			113-116
STORAGE & ACCESSORIES			
Office Accessories			118
Height Adjustable Accessories			119-120
Melamine Lockers			121-122
Steel Lockers, Mesh Lockers & Accessories			123-126
Personal Storage			127-128
Steel Storage			129-133
Presentation			134-136
Free-Standing Screens			136
ACOUSTIC PODS			
B.Quiet Range			137-141
Custom Order Colour Chart			142

Colour Chart

















Metals

-  Black Powdercoat
-  Black Satin
-  Black Ripple
-  Brushed Silver
-  Chrome
-  Graphite Ripple
-  Polished Aluminium
-  Precious Silver
-  Silver Grey
-  Stainless Steel
-  White China
-  White Powdercoat
-  White Satin







Melamine & Stone

-  Beech
-  Cherry
-  Driftwood
-  Grey Carrara marble
-  Gloss White
-  Ironstone
-  Natural Oak
-  Natural White
-  Teak
-  Zebra
-  Black

Textiles

-  Black
-  Black PU
-  Charcoal
-  Coral
-  Dark Grey
-  Emerald
-  Light Grey
-  Olive
-  Rust
-  Stone
-  Tan Leather
-  Tan PU
-  Amber PU
-  French Navy PU
-  Forest Green PU
-  Almond PU
-  Custom Upholstery

Other

-  ECO Screen Marble Grey
-  Pinboard Grey
-  Grey Plastic
-  Green Plastic
-  Slate Grey Plastic
-  White Plastic
-  Black Plastic



RECEPTION

Urban Reception
URC NW/DW

Features:

- Driftwood wrap around cowl feature panel
- Built-in lockable 3 drawer under-desk pedestal
- Built-in CPU & storage cupboard
- 2 x polished aluminium cable entry hole covers
- Adjustable Feet For leveling
- Natural White all over
- E0 melamine board
- 5 year warranty

Specifications:

Overall Size	2200W x 800D x 1150H
Counter Height	1075H
Desk Height	750H



Finish:



RC1809 Reception
RC1809 NW

Features:

- Black powdercoated perforated cowl
- Black matching kick plate
- Natural White all over
- E0 melamine board
- Adjustable Feet For leveling
- 5 year warranty

Specifications:

Overall Size	1800W x 800D x 1170H
Counter Height	1170H
Desk Height	750H



Finish:



Sempre Reception
SEMPRE NO/BL | SEMPRE NO/NW

Features:

- E0 melamine feature module in Black or White
- Natural Oak front and desk
- Powdercoated aluminium strips in black or white
- 500mm wide x 50mm deep scallop cutout in worktop
- Semi assembled, slide-together design
- Support rail under work top
- 5 year warranty

Specifications:

Overall Size	2400W x 950D x 1150H
Counter Height	1050H
Desk Height	730H



Finishes:



Flow Reception
NCT1160

Features:

- Curved reception counter
- Beech coloured E0 rated melamine
- Curved tempered glass counter feature
- Silver kick-plate
- High reception hob for privacy
- Can be used as left or right hand return
- E0 melamine board
- 5 year warranty

Specifications:

Overall Size	2400W x 1600D x 1160H
Glass Counter Height	935H
Desk Height	730H
Hob Size	1600W x 300D x 405H



Finish:



Kali Square
KALI4545

Features:

- Contemporary design to suit a modern work space
- 150mm radius corners
- Available in Charcoal or Stone fabric
- Upholstery options available with lead time
- Adjustable leveling feet
- 5 year warranty

Specifications:

Width	450mm
Depth	450mm
Seat Height	450mm
Weight Rating	150kg



Finishes:



Kali Rectangle
KAL KALI9045

Features:

- Contemporary design to suit a modern work space
- 150mm radius corners
- Available in Charcoal or Stone fabric
- Upholstery options available with lead time
- Adjustable leveling feet
- 5 year warranty

Specifications:

Width	900mm
Depth	450mm
Seat Height	450mm
Weight Rating	200kg



Finishes:





Cosmos Single Seat
COSMOS-1 RUST

Specifications:
Overall Size 810W x 750D x 740H
Seat Size 660W x 550D x 420H
Back Height 200H
Weight Rating 135kg

- Features:**
- Environmentally friendly high-density moulded foam
 - Timber inner frame made from larchwood
 - Quality commercial-grade fabric in Rust
 - Black powdercoat frame
 - 5 year warranty

Finish:



Cosmos 2 Seater
COSMOS-2 RUST

Specifications:
Overall Size 1410W x 750D x 740H
Seat Size 1200W x 550D x 420H
Back Height 200H
Weight Rating 200kg

- Features:**
- Environmentally friendly high-density moulded foam
 - Timber inner frame made from larchwood
 - Black powdercoat frame
 - Quality commercial-grade fabric in Rust
 - 5 year warranty

Finish:



Cosmos 3 Seater
COSMOS-3 RUST

Specifications:
Overall Size 2000W x 750D x 740H
Seat Size 1800W x 550D x 420H
Back Height 200H
Weight Rating 300kg

- Features:**
- Spacious 3 seater lounge
 - Environmentally friendly high-density moulded foam
 - Black powdercoat frame
 - Quality commercial-grade fabric in Rust
 - 5 year warranty

Finish:



Lutie Cross Chair
LUTIE CROSS RUST

Specifications:
Overall Size 755W x 730D x 760H
Seat Size 570W x 515D x 425H
Back Height 335H
Weight Rating 135kg

- Features:**
- Cross base breakout lounge chair
 - Solid steel base finished in black powdercoat
 - Moulded foam seat and backrest
 - Quality commercial-grade fabric in Rust
 - 5 year warranty

Finish:



Lutie Club Chair
LUTIE CLUB OLIVE

Specifications:
Overall Size 755W x 730D x 760H
Seat Size 570W x 515D x 425H
Back Height 335H
Weight Rating 135kg

- Features:**
- 4 star base breakout lounge chair
 - Solid steel base finished in black powdercoat
 - Moulded foam seat and backrest
 - Quality commercial-grade fabric in Olive
 - 5 year warranty

Finish:



NEW

Velto Single Lounge
V1

Specifications:
Overall Size 900W x 740D x 1250H
Seat Size 830W x 540D x 420H
Back Height 830H
Weight Rating 200kg

- Features:**
- High back acoustic lounge designed for privacy
 - Built with sound-absorbing materials to reduce ambient noise
 - Upholstered in commercial-grade Olive fabric
 - Black powdercoat frame
 - 5 year warranty

Finish:



NEW

Velto 2-Seater Lounge
V2

Specifications:
Overall Size 1510W x 740D x 1250H
Seat Size 1350W x 540D x 420H
Back Height 830H
Weight Rating 350kg

- Features:**
- High back acoustic lounge designed for privacy
 - Built with sound-absorbing materials to reduce ambient noise
 - Upholstered in commercial-grade Olive fabric
 - Black powdercoat frame
 - 5 year warranty

Finish:



NEW

Velto 3-Seater Lounge
V3

Specifications:
Overall Size 1890W x 740D x 1250H
Seat Size 1730W x 540D x 420H
Back Height 830H
Weight Rating 400kg

- Features:**
- High back acoustic lounge designed for privacy
 - Built with sound-absorbing materials to reduce ambient noise
 - Upholstered in commercial-grade Olive fabric
 - Black powdercoat frame
 - 5 year warranty

Finish:





Eclipse Single Seat
ECLIP-1 BPU

Specifications:
Overall Size 760W x 730D x 730H
Seat Size 540W x 500D x 435H
Back Height 320H
Weight Rating 150kg

- Features:**
- Easy cleaning and maintenance
 - Chrome feet and wrap around frame
 - Upholstered in quality black PU
 - Adjustable feet for leveling purposes
 - 3 year warranty

Finish:



Eclipse 2 Seater
ECLIP-2 BPU

Specifications:
Overall Size 1250W x 730D x 730H
Seat Size 1030W x 500D x 435H
Back Height 320H
Weight Rating 200kg

- Features:**
- Easy cleaning and maintenance
 - Chrome feet and wrap around frame
 - Upholstered in quality black PU
 - Adjustable feet for leveling purposes
 - 3 year warranty

Finish:



Liso Single Seat
LISO-1 FG

Specifications:
Overall Size 830W x 720D x 700H
Seat Size 560W x 510D x 440H
Back Height 300H
Weight Rating 135kg

- Features:**
- Quality commercial-grade PU leather in Forest Green
 - Contemporary and luxurious design
 - Polished black anodised aluminium feet
 - 3 year warranty

Finish:



Liso 2 Seater
LISO-2 FG

Specifications:
Overall Size 1310W x 720D x 700H
Seat Size 1040W x 510D x 440H
Back Height 300H
Weight Rating 200kg

- Features:**
- Quality commercial-grade PU leather in Forest Green
 - Contemporary and luxurious design
 - Polished black anodised aluminium feet
 - 3 year warranty

Finish:



Eclipse 3 Seater
ECLIP-3 BPU

Specifications:
Overall Size 1710W x 730D x 730H
Seat Size 1500W x 500D x 435H
Back Height 320H
Weight Rating 300kg

- Features:**
- Spacious 3 seater lounge
 - Easy cleaning and maintenance
 - Chrome feet and wrap around frame
 - Upholstered in quality black PU
 - 3 year warranty

Finish:



Myk Lounge Chair
MYK

Specifications:
Overall Size 650W x 710D x 800H
Seat Size 630W x 480D x 430H
Back Height 370H
Weight Rating 135kg

- Features:**
- Available in Light Grey, Olive or Rust fabric
 - Black leather feature strap
 - Quality commercial-grade fabric
 - 5 year warranty

Finish:



Calypso Lounge Chair
CALYPSO LG

Specifications:
Overall Size 800W x 800D x 1080H
Seat Size 535W x 510D x 420H
Back Height 660H
Weight Rating 150kg

- Features:**
- Wing back lounge chair in light grey fabric
 - White Ashwood timber 4-leg base with clear coloured anti-scratch treatment
 - Quality commercial-grade fabric
 - 5 year warranty

Finish:



Liso 3 Seater
LISO-3 FG

Specifications:
Overall Size 1810W x 720D x 700H
Seat Size 1530W x 510D x 440H
Back Height 300H
Weight Rating 300kg

- Features:**
- Spacious 3 seater lounge
 - Quality commercial-grade PU leather in Forest Green
 - Polished black anodised aluminium feet
 - 3 year warranty

Finish:





Capri Single Seat
CAPRI1 LG

Specifications:
Overall 746W x 750D x 830H
Seat 580W x 510D x 450H
Back 580W x 400H
Weight Rating 150kg

- Features:**
- Durable black powdercoated steel base
 - Strong 12mm plywood skeleton
 - High-density foam
 - 3 year warranty

Finish:



Capri 2 Seater
CAPRI2 LG

Specifications:
Overall 1375W x 785D x 830H
Seat 1194W x 510D x 440H
Back 1194W x 400H
Weight Rating 250kg

- Features:**
- Durable black powdercoated steel base
 - Strong 12mm plywood skeleton
 - High-density foam
 - 3 year warranty

Finish:



NEW



Cardinal 1 Seater
CSA

Specifications:
Overall Size 780W x 800D x 880H
Seat Size 450W x 500D x 430H
Back Height 530H
Weight Rating 150kg

- Features:**
- Full fabric upholstery in Charcoal or Stone
 - Removable seat & back cushion
 - Solid tube frame in black powdercoat
 - 5 year warranty

Finishes:



Cardinal 2 Seater
CSA2SE

Specifications:
Overall Size 1335W x 800D x 880H
Seat Size 960W x 500D x 430H
Back Height 530H
Weight Rating 200kg

- Features:**
- Full fabric upholstery in Charcoal or Stone
 - Removable seat & back cushion
 - Solid tube frame in black powdercoat
 - 5 year warranty

Finishes:



Capri 3 Seater
CAPRI3 LG

Specifications:
Overall 1950W x 750D x 830H
Seat 1780W x 510D x 450H
Back 1780W x 400H
Weight Rating 375kg

- Features:**
- Durable black powdercoated steel base
 - Strong 12mm plywood skeleton
 - High-density foam
 - 3 year warranty

Finish:



Aspen Swivel Chair
ASPEN4STA

Specifications:
Overall Size 630W x 630D x 820-880H
Seat Size 480W x 480D x 450-510H
Back Height 370H
Weight Rating 135kg

- Features:**
- 4 Star base finished in black powdercoat
 - 55mm diameter PU castors
 - Upholstered in Light Grey or Olive commercial-grade fabric
 - Gas height adjustment
 - 5 year warranty

Finish:



Aspen Sled Base
ASPENSL

Specifications:
Overall Size 630W x 630D x 820H
Seat Size 480W x 480D x 450H
Back Height 370H
Weight Rating 135kg

- Features:**
- Sled base underframe with 2.0mm steel thickness
 - 16mm diameter steel rod
 - Upholstered in Light Grey or Olive commercial-grade fabric
 - Frame in back powdercoat
 - 5 year warranty

Finish:



Aspen 4-Leg Chair
ASPEN4LE

Specifications:
Overall Size 630W x 630D x 840H
Seat Size 480W x 480D x 480H
Back Height 370H
Weight Rating 135kg

- Features:**
- 4 leg base finished in back powdercoat or solid timber
 - Upholstered in Light Grey or Olive commercial-grade fabric
 - 5 year warranty

Seat Finishes: Base Finishes:



NEW FINISH



Eos Side Table
EHA5T5634

NEW

Specifications:
Overall Size: 560W x 340D x 653 - 1048H

- Features:**
- Height adjustable
 - Maximum load capacity of 10kg
 - 2-stage standard flat oval column
 - Height adjustment mechanism: gas spring
 - 5 year warranty

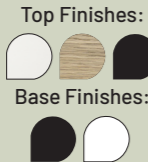

Selene Side Table
SST5634

Specifications:
Overall Size: 560W x 340D x 600H

- Features:**
- Powdercoated underframe
 - Oval base plate
 - E0 Enviroboard melamine surface
 - 5 year warranty

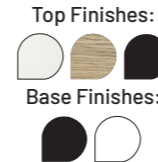

Nido Stone Round
NIMS-CTL | NIMS-CTM | NIMS-ST5

NEW

Specifications:
NIMS-CTL80.37 CAR/BL 800 Diameter x 377H
NIMS-CTM60.30 CAR/BL 600 Diameter x 302H
NIMS-ST550.45 CAR/BL 500 Diameter x 452H

- Features:**
- Grey Carrara 12mm thick sintered stone table top
 - Chamfered edge on top
 - Black powdercoat cross brace underframe
 - Adjustable leveling feet
 - 5 year warranty



Nido Stone Oval
NIMS1206

NEW

Specifications:
Overall Size: 1200W x 500D x 377H

- Features:**
- Grey Carrara 12mm thick sintered stone table top
 - Chamfered edge on top
 - Black powdercoat cross brace underframe
 - Adjustable leveling feet
 - 5 year warranty



Kolo Side Table
KST500-457 | KST600-457
KST500-587 | KST600-587

Specifications:
KST500-457 500 Diameter x 457H
KST600-457 600 Diameter x 457H
KST500-587 500 Diameter x 587H
KST600-587 600 Diameter x 587H

- Features:**
- Pair both heights to create nesting tables
 - 4 leaf cross base underframe finished in powdercoat
 - 25mm E0 melamine board
 - 5 year warranty



Nido Side Table
NIDO-ST5400.635

Specifications:
Overall Size: 400 Diameter x 635H

- Features:**
- Black melamine E0 Enviroboard table top
 - Black powdercoat cross brace underframe
 - Adjustable leveling feet
 - 5 year warranty



Nido Coffee Table
NIDO-CTL | NIDO-CTM

Specifications:
NIDO-CTL800.435 800 Diameter x 435H
NIDO-CTM600.308 600 Diameter x 308H

- Features:**
- Black melamine E0 Enviroboard table top
 - Black powdercoat cross brace underframe
 - Adjustable leveling feet
 - Pair both sizes to create nesting tables
 - 5 year warranty



Nido Oval Coffee Table
NIDO1206

Specifications:
Overall Size: 1200W x 681D x 375H
Lower Surface: 1200W x 500D x 300H
Upper Surface: 750W x 200D x 375H

- Features:**
- Black melamine E0 Enviroboard table top
 - Black powdercoat cross brace underframe
 - Black powdercoat elevated feature console
 - Adjustable leveling feet
 - 5 year warranty





Piedra Coffee Table
PCT126

Specifications:
Overall Size: 1200W x 600D x 420H

- Features:**
- Sleek modern design
 - Grey Carrara marble table top with 12mm T sintered stone
 - 18mm T MFC bottom pad on table top
 - Black powdercoat steel frame
 - 5 year warranty

Finish:



Eternity Rectangular Coffee Table
ECT126

Specifications:
Overall Size 1200W x 600D x 450H

- Features:**
- Powdercoated frame with double support rails
 - E0 melamine board
 - Mix and match top and frame colours
 - 5 year warranty

Top Finishes:



Base Finishes:



Eternity Round Coffee Table
ECT500 | ECT600 | ECT900

Specifications:
ECT500 500 Diameter x 450H
ECT600 600 Diameter x 450H
ECT900 900 Diameter x 450H

- Features:**
- Set of 4 powdercoated legs with adjustable feet
 - ECT500 only available in Natural White, Natural Oak, and Black
 - Matches Eternity workstation range
 - 5 year warranty

Top Finishes:



Base Finishes:



Eternity Square Coffee Table
ECT99

Specifications:
Overall Size 900W x 900D x 450H

- Features:**
- Set of 4 powdercoated legs
 - Adjustable feet
 - Matches Eternity workstation range
 - 5 year warranty

Top Finishes:



Base Finishes:



Estilo Coffee Table
CCT6 | CCT9 | CCT990

Specifications:
CCT6 600 Diameter x 450H
CCT9 900 Diameter x 450H
CCT990 900W x 900D x 450H

- Features:**
- Flat disc base plate
 - CCT990 Square top available in Natural white or Oak only
 - 5 year warranty

Top Finishes:



Base Finishes:



NEW SIZES



Budget Coffee Table
CT96

Specifications:
Overall Size 900W x 600D x 425H

- Features:**
- Robust design with magazine shelf
 - 25mm melamine Beech coloured top
 - 18mm melamine ironstone coloured base
 - E0 melamine board
 - 5 year warranty

Finishes:



Rapid Bloom
SRBVG WH | SRBVG BK

Specifications:
Overall Size 395W x 210D x 1940H
Weight 34kg

- Features:**
- Vertical garden
 - Comes with 8 x 150mm diameter round pots
 - 20kg of polished stones
 - Wall & floor mounting provisions included
 - 5 year warranty
 - *Plants not included

Finishes:



Kolo Coat/Hat Stand
CR1735

Specifications:
Overall Size 500W x 500D x 1730H
Weight Capacity 3kg per hook

- Features:**
- 6x foldaway hanging hooks
 - Easy 2 minute assembly
 - Adjustable leveling feet
 - Powdercoat finish with black poly foldaway hooks and top cap
 - 10 year warranty

Finishes:



WORKSTATION RANGES



D-ELS1P1875 NO/BL



D-ELS2P1875 NW/BL

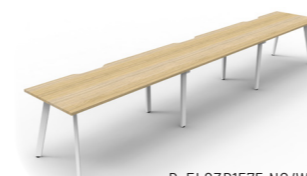

D-ELS3P1575 NO/WS

Eternity Single Sided Workstations

Specifications:

Width Options	1200, 1500, 1800
Top Finish Options	Natural Oak or Natural White
Leg Finish Options	Powdercoat black or white

Dimensions:

Product Code	Users	Width	Depth	Height
D-ELS1P1275	1	1200mm	750mm	730mm
D-ELS1P1575	1	1500mm	750mm	730mm
D-ELS1P1875	1	1800mm	750mm	730mm
D-ELS2P1275	2	2400mm	750mm	730mm
D-ELS2P1575	2	3000mm	750mm	730mm
D-ELS2P1875	2	3600mm	750mm	730mm
D-ELS3P1275	3	3600mm	750mm	730mm
D-ELS3P1575	3	4500mm	750mm	730mm
D-ELS3P1875	3	5400mm	750mm	730mm

Features:

- Eternity range features a stylish angled leg with adjustable feet
- Maximise office space and create runs of connected workstations to meet desired length
- Recessed intermediate legs allow for more comfortable leg space
- Various top sizes available to suit user needs
- Desk height of 730mm
- A generous 750mm deep worktop per user
- Double support rails under each desk
- 5 year warranty

Top Finishes:



Base Finishes:



D-ELSW1P1575 NO/WS



D-ELSW2P1575 NW/WS



D-ELSEP3P1875 WBG

Eternity Single Sided Workstations with Screens

NEW SCREEN OPTIONS

Specifications:

Width Options	1200, 1500, 1800
Top Finish Options	Natural Oak or Natural White
Leg Finish Options	Powdercoat black or white
Screen Options	Black fabric/white frame or Grey fabric/black frame
Eco Panel Options	Black fabric or Marble Grey fabric

Dimensions:

Product Code	Users	Width	Depth (incl. screens)	
			Shush30+	Eco Panel
D-ELSW1P1275 D-ELSEP1P1275	1	1200mm	780mm	760mm
D-ELSW1P1575 D-ELSEP1P1575	1	1500mm	780mm	760mm
D-ELSW1P1875 D-ELSEP1P1875	1	1800mm	780mm	760mm
D-ELSW2P1275 D-ELSEP2P1275	2	2400mm	780mm	760mm
D-ELSW2P1575 D-ELSEP2P1575	2	3000mm	780mm	760mm
D-ELSW2P1875 D-ELSEP2P1875	2	3600mm	780mm	760mm
D-ELSW3P1275 D-ELSEP3P1275	3	3600mm	780mm	760mm
D-ELSW3P1575 D-ELSEP3P1575	3	4500mm	780mm	760mm
D-ELSW3P1875 D-ELSEP3P1875	3	5400mm	780mm	760mm

Features:

- All of the features of the Eternity Single Sided Workstations and more
- Includes a 495mm H x 30mm T Shush30+ screen, or a 384mm H x 27mm T Eco Panel pinnable screen with clamps
- Overall height of 1200mm with Shush30+ screen, and 1130mm with Eco Panel
- 5 year warranty
- *Shush30+ screen is available in customisable Rapidline upholstery colours

Top Finishes:



Base Finishes:



Screen Finishes:



Eco Panel Finishes:





D-ELD2P1575 NO/BL



D-ELD4P1575 NW/BL



D-ELD6P1575 NO/WS

Eternity Double Sided Workstations

Specifications:

Width Options 1200, 1500, 1800
 Top Finish Options Natural Oak or Natural White
 Leg Finish Options Powdercoat black or white

Dimensions:

Product Code	Users	Width	Depth	Height
D-ELD2P1275	2	1200mm	1530mm	730mm
D-ELD2P1575	2	1500mm	1530mm	730mm
D-ELD2P1875	2	1800mm	1530mm	730mm
D-ELD4P1275	4	2400mm	1530mm	730mm
D-ELD4P1575	4	3000mm	1530mm	730mm
D-ELD4P1875	4	3600mm	1530mm	730mm
D-ELD6P1275	6	3600mm	1530mm	730mm
D-ELD6P1575	6	4500mm	1530mm	730mm
D-ELD6P1875	6	5400mm	1530mm	730mm

Features:

- Eternity range features a stylish angled leg with adjustable feet
- Maximise office space with runs of joined back to back desks
- Recessed intermediate legs allows for more comfortable leg space
- Various top sizes available to suit user needs
- Desk height of 730mm
- A generous 750mm deep worktop per user
- Double support rails under each desk
- 5 year warranty

*Infill rail available for purchase

Top Finishes:



Base Finishes:



D-ELDWS2P1575 NO/WS



D-ELDWS4P1575 NW/WS



D-ELDEP6P1875 WBB

Eternity Double Sided Workstations with Screens

NEW SCREEN OPTIONS

Specifications:

Width Options 1200, 1500, 1800
 Top Finish Options Natural Oak or Natural White
 Leg Finish Options Powdercoat black or white
 Screen Options Black fabric/white frame or Grey fabric/black frame
 Eco Panel Options Black fabric or Marble Grey fabric

Dimensions:

Product Code	Users	Width	Overall Depth
D-ELDWS2P1275 D-ELDEP2P1275	2	1200mm	1530mm
D-ELDWS2P1575 D-ELDEP2P1575	2	1500mm	1530mm
D-ELDWS2P1875 D-ELDEP2P1875	2	1800mm	1530mm
D-ELDWS4P1275 D-ELDEP4P1275	4	2400mm	1530mm
D-ELDWS4P1575 D-ELDEP4P1575	4	3000mm	1530mm
D-ELDWS4P1875 D-ELDEP4P1875	4	3600mm	1530mm
D-ELDWS6P1275 D-ELDEP6P1275	6	3600mm	1530mm
D-ELDWS6P1575 D-ELDEP6P1575	6	4500mm	1530mm
D-ELDWS6P1875 D-ELDEP6P1875	6	5400mm	1530mm

Features:

- All of the features of the Eternity Double Sided Workstations and more
- Includes a 495mm H x 30mm T Shush30+ screen, or a 384mm H x 27mm T Eco Panel pinnable screen with clamps
- Overall height of 1200mm with Shush30+ screen, and 1130mm with Eco Panel
- 5 year warranty

*Shush30+ screen is available in customisable Rapidline upholstery colours

Top Finishes:



Base Finishes:



Screen Finishes:



Eco Panel Finishes:



D-ELCWS1P1818 NW / BL



D-ELCWS1P1818 NO / WS



D-ELCWS1P1818 NO / BL

Eternity Corner Workstations

Specifications:

Width Options 1500 x 1500, 1800 x 1500 or 1800 x 1800
 Top Finish Options Natural Oak or Natural White
 Leg Finish Options Powdercoat black or white

Dimensions:

Product Code	Users	Overall Width x Depth	Depth (user depth)	Height
D-ELCWS1P1515	1	1500 x 1500mm	750mm	730mm
D-ELCWS1P1815	1	1800 x 1500mm	750mm	730mm
D-ELCWS1P1818	1	1800 x 1800mm	750mm	730mm

Features:

- Eternity range features a stylish angled leg with adjustable feet
- Maximise desk space with large corner workstations
- All tops come with a single 80mm diameter cable entry hole
- Cockpit style corner for comfortable seating
- Double support rails under each desk
- A generous 750mm deep worktop per user
- 5 year warranty

Top Finishes:



Base Finishes:



D-ELCWS4P1818 NO / WS



D-ELCWS4P1818 NW / BL



D-ELCEP4P1818 OBG

Eternity 4 Person Pod Corner Workstations

NEW SCREEN OPTIONS

Specifications:

Width Options 1500 x 1500, 1800 x 1500 or 1800 x 1800
 Top Finish Options Natural Oak or Natural White
 Leg Finish Options Powdercoat black or white
 Screen Options Black fabric/white frame or Grey fabric/black frame
 Eco Panel Options Black fabric or Marble Grey fabric

Dimensions:

Product Code	Users	Overall Width x Depth	Depth (user depth)
D-ELCWS4P1515 D-ELCEP4P1515	4	3030 x 3030mm	750mm
D-ELCWS4P1815 D-ELCEP4P1815	4	3630 x 3030mm	750mm
D-ELCWS4P1818 D-ELCEP4P1818	4	3630 x 3630mm	750mm

Features:

- All of the features of the Eternity Corner Workstation and more
- Includes a 495mm H x 30mm T Shush30+ screen, or a 384mm H x 27mm T Eco Panel pinnable screen with clamps
- Overall height of 1200mm with Shush30+ screen, and 1130mm with Eco Panel
- 5 year warranty

*Shush30+ screen is available in customisable Rapidline upholstery colours

Top Finishes:



Base Finishes:



Screen Finishes:



Eco Panel Finishes:





Eternity Desk & Return

D-ELDR18185

Specifications:

Overall Size 1800W x 1850D x 730H
 Desk Depth 750D at desk, 600D at return
 Leg Finish Options Powdercoat black or white

Components:

Product	Code	Width	Depth	Height
Return Leg	ERL600	600mm	-	695mm
Return Top	TT16	1100mm	600mm	25mm
Single Leg Set	D-ESL	749mm	233mm	695mm
Scalloped Table Top	DST1875	1800mm	750mm	25mm
Rail Clamp Set	IRC	129mm	32mm	40mm
Telescopic Rail Set	ITR1012	926-1306mm	25mm	40mm
Telescopic Rail Set	ITR1518	1226-1826mm	25mm	40mm

Features:

- 2 piece top with 90° corner and double support rails
- 25mm thick E0 melamine board in Natural Oak or Natural White
- Scalloped edge for cable access on one side
- Dual cross bar for added stability
- 5 year warranty

Top Finishes:



Base Finishes:



D-IEL3P120D NO/WS



D-IEL3P120D NW/WS



D-IELWS3P120D NO/BL



D-IEL3P120D WBB

Eternity Leg 120° Pods

Features:

- Use 120° pods to maximise office space
- E0 Enviroboard melamine worksurface
- Tops come with a 80mm diameter cable entry hole
- 60mm x 30mm Eternity leg powdercoated underframe
- 30mm cable access void between double sided users - infill rail available at an additional cost
- Create runs of pods to suit office requirements
- Add-on Shush30+ privacy screens or Eco Panel pinnable screens
- Dual cross bar for added stability
- Adjustable leveling feet
- 5 year warranty

Dimensions:

Product Code	Screen	Overall Width x Depth	Width x Depth (per user)	Height (inc. screens)
D-IEL3P120D	No	2866 x 2480mm	1205 x 1205mm	730mm
D-IELWS3P120D	Yes	2866 x 2480mm	1205 x 1205mm	1200mm
D-IEL3P120D	Yes	2866 x 2480mm	1205 x 1205mm	1130mm



Top Finishes:



Base Finishes:



Screen Finishes:



Eco Panel Finishes:



NEW SCREEN OPTIONS



D-IPLS1P1875 NO/WS



D-IPLS2P1875 NW/WS



D-IPLS3P1875 NO/BL

Profile Leg Single Sided Workstations

Specifications:

Width Options 1200, 1500, 1800
 Top Finish Options Natural Oak or Natural White
 Leg Finish Options Powdercoat black or white

Dimensions:

Product Code	Users	Width	Depth	Height
D-IPLS1P1275	1	1200mm	750mm	730mm
D-IPLS1P1575	1	1500mm	750mm	730mm
D-IPLS1P1875	1	1800mm	750mm	730mm
D-IPLS2P1275	2	2400mm	750mm	730mm
D-IPLS2P1575	2	3000mm	750mm	730mm
D-IPLS2P1875	2	3600mm	750mm	730mm
D-IPLS3P1275	3	3600mm	750mm	730mm
D-IPLS3P1575	3	4500mm	750mm	730mm
D-IPLS3P1875	3	5400mm	750mm	730mm

Features:

- Profile leg range features a classic leg set with adjustable feet
- Maximise office space and create runs of connected workstations to meet desired length
- Recessed intermediate legs allow for more comfortable leg space
- Various top sizes available to suit user needs
- Desk height of 730mm
- A generous 750mm deep worktop per user
- Double support rails under each desk
- 5 year warranty

Top Finishes:



Base Finishes:



D-IPLSWS1P1875 NW/BL



D-IPLSWS2P1875 NO/WS



D-IPLSEP3P1875 WWB

Profile Leg Single Sided Workstations with Screens

Specifications:

Width Options 1200, 1500, 1800
 Top Finish Options Natural Oak or Natural White
 Leg Finish Options Powdercoat black or white
 Screen Options Black fabric/white frame or Grey fabric/black frame
 Eco Panel Options Black fabric or Marble Grey fabric

Dimensions:

Product Code	Users	Width	Depth (incl. screens)	
			Shush30+	Eco Panel
D-IPLSWS1P1275 D-IPLSEP1P1275	1	1200mm	780mm	760mm
D-IPLSWS1P1575 D-IPLSEP1P1575	1	1500mm	780mm	760mm
D-IPLSWS1P1875 D-IPLSEP1P1875	1	1800mm	780mm	760mm
D-IPLSWS2P1275 D-IPLSEP2P1275	2	2400mm	780mm	760mm
D-IPLSWS2P1575 D-IPLSEP2P1575	2	3000mm	780mm	760mm
D-IPLSWS2P1875 D-IPLSEP2P1875	2	3600mm	780mm	760mm
D-IPLSWS3P1275 D-IPLSEP3P1275	3	3600mm	780mm	760mm
D-IPLSWS3P1575 D-IPLSEP3P1575	3	4500mm	780mm	760mm
D-IPLSWS3P1875 D-IPLSEP3P1875	3	5400mm	780mm	760mm

Features:

- All of the features of the Profile Leg Single Sided Workstations and more
- Includes a 495mm H x 30mm T Shush30+ screen, or a 384mm H x 27mm T Eco Panel pinnable screen with clamps
- Overall height of 1200mm with Shush30+ screen, and 1130mm with Eco Panel
- 5 year warranty

*Shush30+ screen is available in customisable Rapidline upholstery colours

Top Finishes:



Base Finishes:



Screen Finishes:



Eco Panel Finishes:



NEW SCREEN OPTIONS



D-IPLD2P1875 NO/BL



D-IPLD4P1875 NW/BL



D-IPLD6P1875 NO/WS

Profile Leg Double Sided Workstations

Specifications:
 Width Options 1200, 1500, 1800
 Top Finish Options Natural Oak or Natural White
 Leg Finish Options Powdercoat black or white

Dimensions:

Product Code	Users	Width	Depth	Height
D-IPLD2P1275	2	1200mm	1530mm	730mm
D-IPLD2P1575	2	1500mm	1530mm	730mm
D-IPLD2P1875	2	1800mm	1530mm	730mm
D-IPLD4P1275	4	2400mm	1530mm	730mm
D-IPLD4P1575	4	3000mm	1530mm	730mm
D-IPLD4P1875	4	3600mm	1530mm	730mm
D-IPLD6P1275	6	3600mm	1530mm	730mm
D-IPLD6P1575	6	4500mm	1530mm	730mm
D-IPLD6P1875	6	5400mm	1530mm	730mm

Features:

- Profile leg range features a classic leg set with adjustable feet
- Maximise office space with runs of joined back to back desks
- Recessed intermediate legs allow for more comfortable leg space
- Various top sizes available to suit user needs
- Desk height of 730mm
- A generous 750mm deep worktop per user
- Double support rails under each desk
- 5 year warranty

*Infill panel available for purchase

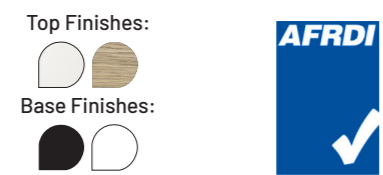

D-IPLDWS2P1875 NO/WS



D-IPLDWS4P1875 NW/WS



D-IPLDEP6P1875 OBG

Profile Leg Double Sided Workstations with Screens

NEW SCREEN OPTIONS

Specifications:
 Width Options 1200, 1500, 1800
 Top Finish Options Natural Oak or Natural White
 Leg Finish Options Powdercoat black or white
 Screen Options Black fabric/white frame or Grey fabric/black frame
 Eco Panel Options Black fabric or Marble Grey fabric

Dimensions:

Product Code	Users	Width	Overall Depth
D-IPLDWS2P1275 D-IPLDEP2P1275	2	1200mm	1530mm
D-IPLDWS2P1575 D-IPLDEP2P1575	2	1500mm	1530mm
D-IPLDWS2P1875 D-IPLDEP2P1875	2	1800mm	1530mm
D-IPLDWS4P1275 D-IPLDEP4P1275	4	2400mm	1530mm
D-IPLDWS4P1575 D-IPLDEP4P1575	4	3000mm	1530mm
D-IPLDWS4P1875 D-IPLDEP4P1875	4	3600mm	1530mm
D-IPLDWS6P1275 D-IPLDEP6P1275	6	3600mm	1530mm
D-IPLDWS6P1575 D-IPLDEP6P1575	6	4500mm	1530mm
D-IPLDWS6P1875 D-IPLDEP6P1875	6	5400mm	1530mm

Features:

- All of the features of the Profile Leg Double Sided Workstations and more
- Includes a 495mm H x 30mm T Shush30+ screen, or a 384mm H x 27mm T Eco Panel pinnable screen with clamps
- Overall height of 1200mm with Shush30+ screen, and 1130mm with Eco Panel
- 5 year warranty

*Shush30+ screen is available in customisable Rapidline upholstery colours

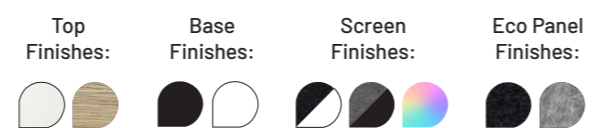

D-IPLCWS1P1815 NO/BL



D-IPLCWS1P1818 NW/BL



D-IPLCWS1P1818 NO/WS

Profile Leg Corner Workstations

Specifications:
 Width Options 1500 x 1500, 1800 x 1500 or 1800 x 1800
 Top Finish Options Natural Oak or Natural White
 Leg Finish Options Powdercoat black or white

Dimensions:

Product Code	Users	Overall Width x Depth	Depth (user depth)	Height
D-IPLCWS1P1515	1	1500 x 1500mm	750mm	730mm
D-IPLCWS1P1815	1	1800 x 1500mm	750mm	730mm
D-IPLCWS1P1818	1	1800 x 1800mm	750mm	730mm

Features:

- Profile leg range features a classic leg set with adjustable feet
- Maximise desk space with large corner workstations
- All tops come with a single 80mm diameter cable entry hole
- Cockpit style corner for comfortable seating
- Double support rails under each desk
- 5 year warranty



D-IPLCWS4P1815 NO/WS

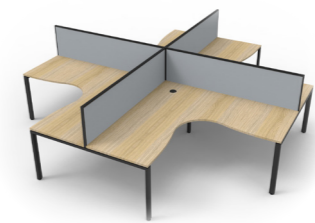

D-IPLCWS4P1818 NO/BL



D-IPLCEP4P1818 WWB

Profile Leg 4 Person Corner Workstations

NEW SCREEN OPTIONS

Specifications:
 Width Options 1500 x 1500, 1800 x 1500 or 1800 x 1800
 Top Finish Options Natural Oak or Natural White
 Leg Finish Options Powdercoat black or white
 Screen Options Black fabric/white frame or Grey fabric/black frame
 Eco Panel Options Black fabric or Marble Grey fabric

Dimensions:

Product Code	Users	Overall Width x Depth	Depth (user depth)
D-IPLCWS4P1515 D-IPLCEP4P1515	4	3030 x 3030mm	750mm
D-IPLCWS4P1815 D-IPLCEP4P1815	4	3630 x 3030mm	750mm
D-IPLCWS4P1818 D-IPLCEP4P1818	4	3630 x 3630mm	750mm

Features:

- All of the features of the Profile Leg Corner Workstations and more
- Includes 495mm H x 30mm T Shush30+ screens, or 384mm H x 27mm T Eco Panel pinnable screens with clamps
- Overall height of 1200mm with Shush30+ screen, and 1130mm with Eco Panel
- 5 year warranty

*Shush30+ screen is available in customisable Rapidline upholstery colours

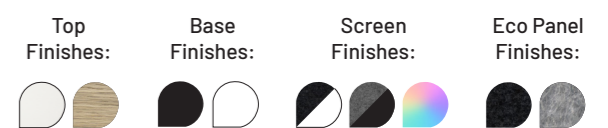



Profile Desk & Return

D-IPLDR18185

Specifications:

Overall Size 1800W x 1850D x 730H
 Desk Depth 750D at desk, 600D at return
 Leg Finish Options Powdercoat black or white

Components:

Product	Code	Width	Depth	Height
Return Leg	PRL600	600mm	-	695mm
Return Top	TT16	1100mm	600mm	25mm
Single Leg Set	D-PSL	750mm	120mm	695mm
Scalloped Table Top	DST1875	1800mm	750mm	25mm
Rail Clamp Set	IRC	129mm	32mm	40mm
Telescopic Rail Set	ITR1012	926-1306mm	25mm	40mm
Telescopic Rail Set	ITR1518	1226-1826mm	25mm	40mm

Features:

- 2 piece top with 90° corner and double support rails
- 25mm thick E0 melamine board in Natural Oak or Natural White
- Scalloped edge for cable access on one side
- Dual cross bar for added stability
- 5 year warranty

Top Finishes:



Base Finishes:



D-IPL3P120D NO/BL



D-IPL3P120D NW/WS



D-IPLWS3P120D NW/BL



D-IPL3P120D OWG

Profile Leg 120° Pods

Features:

- Use 120° pods to maximise office space
- E0 Enviroboard melamine worksurface
- Tops come with a 80mm diameter cable entry hole
- 60mm x 30mm Profile leg powdercoated underframe
- 30mm cable access void between double sided users - infill rail available at an additional cost
- Create runs of pods to suit office requirements
- Add-on Shush30+ privacy screens or Eco Panel pinnable screens
- Dual cross bar for added stability
- Adjustable leveling feet
- 5 year warranty

Dimensions:

Product Code	Screen	Overall Width x Depth	Width x Depth (per user)	Height (incl. screens)
D-IPL3P120D	No	2866 x 2480mm	1205 x 1205mm	730mm
D-IPLWS3P120D	Yes	2866 x 2480mm	1205 x 1205mm	1200mm
D-IPL3P120D	Yes	2866 x 2480mm	1205 x 1205mm	1130mm



Top Finishes:



Base Finishes:



Screen Finishes:



Eco Panel Finishes:



NEW SCREEN OPTIONS



D-ILLS1P1875 NO/BL



D-ILLS2P1875 NW/BL

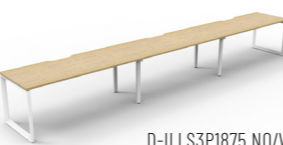

D-ILLS3P1875 NO/WS

Loop Leg Single Sided Workstations

Specifications:

Width Options 1200, 1500, 1800
 Top Finish Options Natural Oak or Natural White
 Leg Finish Options Powdercoat black or white

Dimensions:

Product Code	Users	Width	Depth	Height
D-ILLS1P1275	1	1200mm	750mm	730mm
D-ILLS1P1575	1	1500mm	750mm	730mm
D-ILLS1P1875	1	1800mm	750mm	730mm
D-ILLS2P1275	2	2400mm	750mm	730mm
D-ILLS2P1575	2	3000mm	750mm	730mm
D-ILLS2P1875	2	3600mm	750mm	730mm
D-ILLS3P1275	3	3600mm	750mm	730mm
D-ILLS3P1575	3	4500mm	750mm	730mm
D-ILLS3P1875	3	5400mm	750mm	730mm

Features:

- Loop leg range features a modern looped leg set with adjustable feet
- Maximise office space and create runs of connected workstations to meet desired length
- Recessed intermediate legs allow for more comfortable leg space
- Various top sizes available to suit user needs
- Desk height of 730mm
- A generous 750mm deep worktop per user
- Double support rails under each desk
- 5 year warranty

Top Finishes:



Base Finishes:



D-ILLSWS1P1875 NW/WS



D-ILLSWS2P1875 NO/BL



D-ILLSEP3P1875 WBG

Loop Leg Single Sided Workstations with Screens

Specifications:

Width Options 1200, 1500, 1800
 Top Finish Options Natural Oak or Natural White
 Leg Finish Options Powdercoat black or white
 Screen Options Black fabric/white frame or Grey fabric/black frame
 Eco Panel Options Black fabric or Marble Grey fabric

Dimensions:

Product Code	Users	Width	Depth (incl. screens)	
			Shush30+	Eco Panel
D-ILLSWS1P1275 D-ILLSEP1P1275	1	1200mm	780mm	760mm
D-ILLSWS1P1575 D-ILLSEP1P1575	1	1500mm	780mm	760mm
D-ILLSWS1P1875 D-ILLSEP1P1875	1	1800mm	780mm	760mm
D-ILLSWS2P1275 D-ILLSEP2P1275	2	2400mm	780mm	760mm
D-ILLSWS2P1575 D-ILLSEP2P1575	2	3000mm	780mm	760mm
D-ILLSWS2P1875 D-ILLSEP2P1875	2	3600mm	780mm	760mm
D-ILLSWS3P1275 D-ILLSEP3P1275	3	3600mm	780mm	760mm
D-ILLSWS3P1575 D-ILLSEP3P1575	3	4500mm	780mm	760mm
D-ILLSWS3P1875 D-ILLSEP3P1875	3	5400mm	780mm	760mm

Features:

- All of the features of the Loop Leg Single Sided Workstations and more
- Includes a 495mm H x 30mm T Shush30+ screen, or a 384mm H x 27mm T Eco Panel pinnable screen with clamps
- Overall height of 1200mm with Shush30+ screen, and 1130mm with Eco Panel
- 5 year warranty
- *Shush30+ screen is available in customisable Rapidline upholstery colours

Top Finishes:



Base Finishes:



Screen Finishes:



Eco Panel Finishes:





D-ILLD2P1875 NW/BL



D-ILLD4P1875 NO/WS



D-ILLD6P1875 NO/BL

Loop Leg Double Sided Workstations

Specifications:

Width Options 1200, 1500, 1800
 Top Finish Options Natural Oak or Natural White
 Leg Finish Options Powdercoat black or white

Dimensions:

Product Code	Users	Width	Depth	Height
D-ILLD2P1275	2	1200mm	1530mm	730mm
D-ILLD2P1575	2	1500mm	1530mm	730mm
D-ILLD2P1875	2	1800mm	1530mm	730mm
D-ILLD4P1275	4	2400mm	1530mm	730mm
D-ILLD4P1575	4	3000mm	1530mm	730mm
D-ILLD4P1875	4	3600mm	1530mm	730mm
D-ILLD6P1275	6	3600mm	1530mm	730mm
D-ILLD6P1575	6	4500mm	1530mm	730mm
D-ILLD6P1875	6	5400mm	1530mm	730mm

Features:

- Loop leg range features a modern looped leg set with adjustable feet
- Maximise office space with runs of joined back to back desks
- Recessed intermediate legs allow for more comfortable leg space
- Various top sizes available to suit user needs
- Desk height of 730mm
- A generous 750mm deep worktop per user
- Double support rails under each desk
- 5 year warranty

* Infill panel available for purchase

Top Finishes:



Base Finishes:



D-ILLDWS2P1875 NW/WS

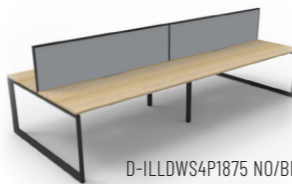

D-ILLDWS4P1875 NO/BL



D-ILLDEP6P1875 OWB

Loop Leg Double Sided Workstations with Screens

NEW SCREEN OPTIONS

Specifications:

Width Options 1200, 1500, 1800
 Top Finish Options Natural Oak or Natural White
 Leg Finish Options Powdercoat black or white
 Screen Options Black fabric/white frame or Grey fabric/black frame
 Eco Panel Options Black fabric or Marble Grey fabric

Dimensions:

Product Code	Users	Width	Overall Depth
D-ILLDWS2P1275 D-ILLDEP2P1275	2	1200mm	1530mm
D-ILLDWS2P1575 D-ILLDEP2P1575	2	1500mm	1530mm
D-ILLDWS2P1875 D-ILLDEP2P1875	2	1800mm	1530mm
D-ILLDWS4P1275 D-ILLDEP4P1275	4	2400mm	1530mm
D-ILLDWS4P1575 D-ILLDEP4P1575	4	3000mm	1530mm
D-ILLDWS4P1875 D-ILLDEP4P1875	4	3600mm	1530mm
D-ILLDWS6P1275 D-ILLDEP6P1275	6	3600mm	1530mm
D-ILLDWS6P1575 D-ILLDEP6P1575	6	4500mm	1530mm
D-ILLDWS6P1875 D-ILLDEP6P1875	6	5400mm	1530mm

Features:

- All of the features of the Loop Leg Double Sided Workstations and more
- Includes a 495mm H x 30mm T Shush30+ screen, or a 384mm H x 27mm T Eco Panel pinnable screen with clamps
- Overall height of 1200mm with Shush30+ screen, and 1130mm with Eco Panel
- 5 year warranty

*Shush30+ screen is available in customisable Rapidline upholstery colours

Top Finishes:



Base Finishes:



Screen Finishes:



Eco Panel Finishes:



D-ILLCWS1P1815 NW/BL



D-ILLCWS1P1818 NW/WS



D-ILLCWS1P1818 NO/WS

Loop Leg Corner Workstations

Specifications:

Width Options 1500 x 1500, 1800 x 1500 or 1800 x 1800
 Top Finish Options Natural Oak or Natural White
 Leg Finish Options Powdercoat black or white

Dimensions:

Product Code	Users	Overall Width x Depth	Depth (user depth)	Height
D-ILLCWS1P1515	1	1500 x 1500mm	750mm	730mm
D-ILLCWS1P1815	1	1800 x 1500mm	750mm	730mm
D-ILLCWS1P1818	1	1800 x 1800mm	750mm	730mm

Features:

- Loop leg range features a modern looped leg set with adjustable feet
- Maximise desk space with large corner workstations
- All tops come with a single 80mm diameter cable entry hole
- Cockpit style corner for comfortable seating
- Double support rails under each desk
- 5 year warranty

Top Finishes:



Base Finishes:



D-ILLCWS4P1815 NO/BL

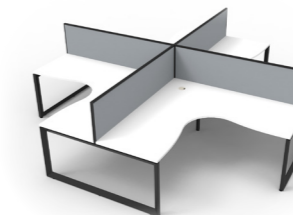

D-ILLCWS4P1818 NW/BL



D-ILLCEP4P1818 OWB

Loop Leg 4 Person Corner Workstations

NEW SCREEN OPTIONS

Specifications:

Width Options 1500 x 1500, 1800 x 1500 or 1800 x 1800
 Top Finish Options Natural Oak or Natural White
 Leg Finish Options Powdercoat black or white
 Screen Options Black fabric/white frame or Grey fabric/black frame
 Eco Panel Options Black fabric or Marble Grey fabric

Dimensions:

Product Code	Users	Overall Width x Depth	Depth (user depth)
D-ILLCWS4P1515 D-ILLCEP4P1515	4	3030 x 3030mm	750mm
D-ILLCWS4P1815 D-ILLCEP4P1815	4	3630 x 3030mm	750mm
D-ILLCWS4P1818 D-ILLCEP4P1818	4	3630 x 3630mm	750mm

Features:

- All of the features of the Loop leg corner workstation and more
- Includes 495mm H x 30mm T Shush30+ screens, or 384mm H x 27mm T Eco Panel pinnable screens with clamps
- Overall height of 1200mm with Shush30+ screen, and 1130mm with Eco Panel
- 5 year warranty

*Shush30+ screen is available in customisable Rapidline upholstery colours

Top Finishes:



Base Finishes:



Screen Finishes:



Eco Panel Finishes:



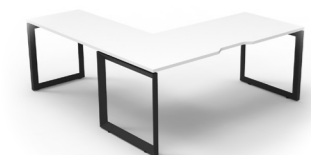
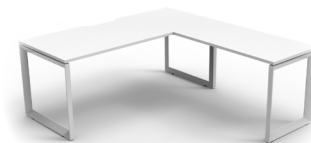

Loop Desk & Return

D-ILLDR18185

Specifications:

Overall Size 1800W x 1850D x 730H
 Desk Depth 750D at desk, 600D at return
 Leg Finish Options Powdercoat black or white

Components:

Product	Code	Width	Depth	Height
Return Leg	LRL600	600mm	-	695mm
Return Top	T116	1100mm	600mm	25mm
Single Leg Set	D-LSL	750mm	105mm	695mm
Scalloped Table Top	DST1875	1800mm	750mm	25mm
Rail Clamp Set	IRC	129mm	32mm	40mm
Telescopic Rail Set	ITR1012	926-1306mm	25mm	40mm
Telescopic Rail Set	ITR1518	1226-1826mm	25mm	40mm

Features:

- 2 piece top with 90° corner and double support rails
- 25mm thick E0 melamine board in Natural Oak or Natural White
- Scalloped edge for cable access on one side
- Dual cross bar for added stability
- 5 year warranty

Top Finishes:



Base Finishes:



D-ILL3P120D NO/BL



D-ILL3P120D NO/WS



D-ILLWS3P120D NW/WS



D-ILLEP3P120D WBG

Loop Leg 120° Pods

NEW SCREEN OPTIONS

Features:

- Use 120° pods to maximise office space
- E0 Enviroboard melamine worksurface
- Tops come with a 80mm diameter cable entry hole
- 60mm x 30mm Loop leg powdercoated underframe
- 30mm cable access void between double sided users - infill rail available at an additional cost
- Create runs of pods to suit office requirements
- Add-on Shush30+ privacy screens or Eco Panel pinnable screens
- Dual cross bar for added stability
- Adjustable leveling feet
- 5 year warranty

Dimensions:

Product Code	Screen	Overall Width x Depth	Width x Depth (per user)	Height (inc. screens)
D-ILL3P120D	No	2866 x 2480mm	1205 x 1205mm	730mm
D-ILLWS3P120D	Yes	2866 x 2480mm	1205 x 1205mm	1200mm
D-ILLEP3P120D	Yes	2866 x 2480mm	1205 x 1205mm	1130mm



Top Finishes:



Base Finishes:



Screen Finishes:



Eco Panel Finishes:

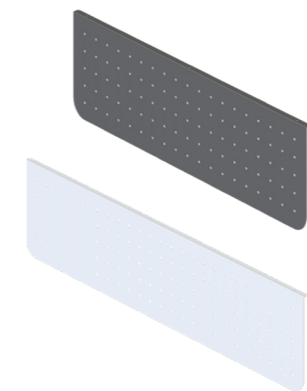

Arch Perforated Modesty Panel

PSM1000 | PSM1300 | PSM1600

Specifications:

PSM1000 1000W x 20D x 300H
 PSM1300 1300W x 20D x 300H
 PSM1600 1600W x 20D x 300H

Features:

- Provides privacy by attaching to the underside of workstations
- Available in black or white powdercoat to suit workstation frame
- Use with Deluxe Infinity, Boost and Halo workstations
- 1.5mm steel gauge
- 10 year warranty

Finishes:



Clamp-Mount Shelf

CMSHELF

Specifications:

Overall Size 600W x 270D x 475H

Features:

- 25mm thick E0 rated enviroboard
- Comes with 4 x wire dividers
- Convenient shelf above desk
- Clamps onto desk top
- Comes in Natural Oak/Black or Natural White/White
- 5 year warranty

Finishes:



Screen-Hung Shelf

ISHELF600

Specifications:

Overall Size 600W x 270D x 250H

Features:

- 18mm thick E0 rated enviroboard
- Powdercoated steel shelf brackets
- Hangs from Infinity and SHUSH30+ screens
- Comes in Natural Oak/Black or Natural White/White
- 5 year warranty

Finishes:

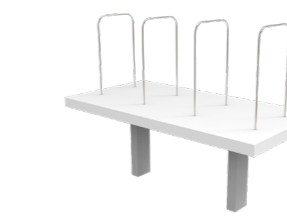

Desk-Mounted Shelf

DMSHELF

Specifications:

Overall Size 600W x 300D x 450H
 Height 208mm from desk to bottom of shelf

Features:

- 25mm thick E0 rated enviroboard
- Comes with 4 x wire dividers
- Requires mounting onto desk
- Comes in Natural Oak/Black or Natural White/White
- 5 year warranty

Finishes:



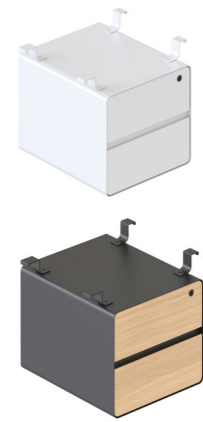

Deluxe 2 Drawer Hanging Ped
D-HP2D

Specifications:
Overall Size 400W x 480D x 350H

- Features:**
- Steel unit with melamine drawer fronts
 - For use with Deluxe Infinity Profile, Loop, and Eternity fixed height workstations
 - Available in three colour variations
 - 5 year warranty

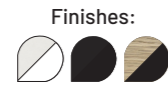

Return Legs
PRL600 | LRL600 | ERL600

Specifications:
Overall Size 600W x 695H

- Features:**
- Use as a return leg for desks with returns
 - Use where recessed legs are required
 - Adjustable leveling feet
 - 5 year warranty



Rail Clamp
IRC

Specifications:
Overall Size 129W x 32D x 40H

- Features:**
- Used for corner desks or desks with returns
 - Clamps to double support rails
 - Comes in set of 2
 - 5 year warranty



Infinity Bookcase
IFBK12 | IFBK18

Specifications:
IFBK12 900W x 315D x 1200H
IFBK18 900W x 315D x 1800H

- Features:**
- Adjustable shelves
 - Black edging feature
 - Aluminium tapered legs
 - 25mm thick shelves, 18mm sides
 - E0 rated melamine board
 - 5 year warranty

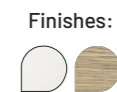

Infinity Swing Door Cupboards
IFSD

Specifications:
IFSD96 2 Door - 900W x 600D x 730H
IFSD1245 3 Door - 1200W x 450D x 730H
IFSD1545 3 Door - 1500W x 450D x 730H
IFSD1845 4 Door - 1800W x 450D x 730H

- Features:**
- Lockable doors, supplied with 2 keys
 - Shark nose feature on tops of doors, soft close hinges
 - E0 rated melamine board with black edging
 - 5 year warranty

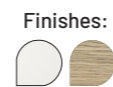

Infill Rail
D-IF12 | D-IF15 | D-IF18

Specifications:
D-IF12 1200W x 30D x 30H
D-IF15 1500W x 30D x 30H
D-IF18 1800W x 30D x 30H

- Features:**
- Fills 30mm gap between double sided Deluxe Infinity and Eternity ranges



Fixed Rail
FR2400

Specifications:
Overall Size 2326W x 25D x 40H

- Features:**
- Used for 2400mm long boardroom tables
 - Suits Profile, Loop and Eternity legs
 - Comes as a set of 2
 - 5 year warranty





Telescopic Rail
ITR1012 | ITR1518 | ITR7011

Specifications:
ITR1012 Use for 1200mm wide desks
ITR1518 1500-1800mm wide desks
ITR7011 Use for corner workstations

- Features:**
- Comes as a set of 2
 - Finished in black or white powdercoat to suit workstation
 - 5 year warranty



Extra Long Rail
ITR1821

Specifications:
Overall Size 1726-2106W x 30D x 30H

- Features:**
- Used for 1800-2100mm wide desks
 - Double support rails to strengthen top
 - Comes as a set of 2
 - Finished in black or white powdercoat to suit workstation
 - 5 year warranty

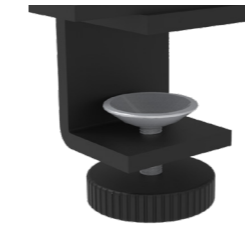

Screen Clamp
SHS-CL

Specifications:
Overall Size 80W x 44D x 66H

- Features:**
- Screens mounted using this clamp will sit above desk tops
 - Suits desk thickness up to 26mm
 - Comes as set of 2

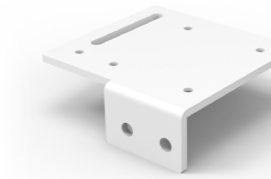
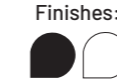

Single Fixing
SHS-FS

Specifications:
Overall Size 122W x 100D x 40H

- Features:**
- Screens mounted using this clamp will sit flush with desk top
 - Suits desk thickness up to 26mm
 - Comes as set of 2

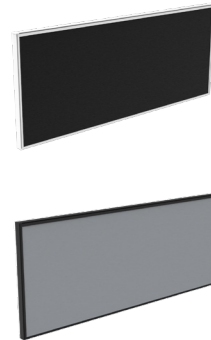

495H Screen
SHS754 | SHS1204
SHS1504 | SHS1804

Specifications:
SHS754 750W x 30D x 495H
SHS1204 1200W x 30D x 495H
SHS1504 1500W x 30D x 495H
SHS1804 1800W x 30D x 495H

- Features:**
- Full fabric screen with top rail for accessory hanging
 - Pinnable EVA surface
 - 5 years warranty



Joining Poles
SHSJP495

Specifications:
Overall Size 30W x 30D x 495H

- Features:**
- Used for joining and stabilising return screen
 - Used where screens join at 90°
 - 5 year warranty



Double Fixing
SHS-FD

Specifications:
Overall Size 100W x 70D x 40H

- Features:**
- Used for back to back desk configurations
 - Used for fixing SHS desk mounted screens
 - Suits desk thickness up to 26mm
 - Comes as set of 2



Return Fixing
SHS-LB | SHS-TB

Specifications:
Overall Size 120W x 50D x 5H

- Features:**
- For use with 750mm wide return screens
 - Single screw plate only, not sold in pairs
 - SHS-LB use with single desks
 - SHS-TB use with back to back desks



CASA EXECUTIVE



CP-RIG218 NO/WS-NOW



CL-RIG218 NO/BL-NOW



CE-LEF218 NO/WS-NOW



CP-LEF218 NO/BL-NOW

Casa Executive Workstation

Features:

- Workstation to suit Casa Executive range
- Casa table top and modesty panel paired with Casa side cabinet to create a cockpit style workstation with storage
- Left-hand side and right-hand side configurations available to suit any office layout
- Use with Eternity, Profile, or Loop legs
- 800mm D work surface and 600mm D side cabinet
- Worksurface includes a cable tidy box with brush strip dualway lid
- 2 x lockable drawers fitted with cyberlock 4 digit combination lock and soft close runners
- 1 x swing door cupboard with adjustable shelf with soft close hinges
- 1 x open shelf compartment with 1 adjustable shelf
- 350mm H modesty panel for privacy when visible from the front
- Shark nose edge profile to table top
- Legs available in black or white powdercoat
- Natural Oak worksurface with Natural White profiles, modesty panel, doors and drawers
- 5 year warranty

Specifications:

Product Code	Leg Type	Left/Right	Overall Size	Desk Height
CE-LEF218	Eternity	Left	2000 x 1800mm	748mm
CP-LEF218	Profile	Left	2000 x 1800mm	748mm
CL-LEF218	Loop	Left	2000 x 1800mm	748mm
CE-RIG218	Eternity	Right	2000 x 1800mm	748mm
CP-RIG218	Profile	Right	2000 x 1800mm	748mm
CL-RIG218	Loop	Right	2000 x 1800mm	748mm

Workstation Finish:



Leg Finishes:



CASA EXECUTIVE RANGE



Casa Executive Shelving Unit CAS-SU1812

Specifications:

Overall Size	1800W x 400D x 1250H
Storage Cubes Size	354W x 354D x 363H
Storage Opening Size	966W x 354D x 362H

Features:

- Shelving and storage unit to suit Casa Executive range
- 1 x double swing door cupboard with 1 x adjustable shelf inside
- 6 x storage cubes and 1 x storage opening
- Natural Oak outer carcass and swing doors with Natural White inner profiles
- 5 year warranty

Finish:



Casa Executive Swing Door Cupboard CAS-SDC1808

Specifications:

Overall Size	1800W x 400D x 800H
--------------	---------------------

Features:

- Swing Door Cupboard to suit Casa Executive range
- 4 x swing doors
- 2 x adjustable shelves
- Natural Oak outer carcass and swing doors with Natural White inner profiles
- 5 year warranty

Finish:





Deluxe Rapid Span Single Sided Workstations

Features:

- Sturdy powdercoated frame and legs
- Comes with metal perforated modesty panel
- Range of sizes to choose from to suit your space
- E0 melamine top
- Scalloped edge for cable tidy
- 750mm deep top for more workspace
- Hidden cable tidy in legs
- Adjustable feet
- Top available in Natural White or Natural Oak
- Frame and legs in powdercoated black, silver or white
- 5 year warranty

Specifications:

Product Code	Width	Top Depth	Height
RSD1275M	1200mm	750mm	730mm
RSD1575M	1500mm	750mm	730mm
RSD1875M	1800mm	750mm	730mm

Top Finishes:



Base Finishes:



Deluxe Rapid Span Corner Workstations

Features:

- Corner top for more work surface area
- Sturdy powdercoated frame and legs
- Comes with metal perforated modesty panel
- Range of sizes to choose from to suit your space
- E0 melamine top
- Pre-cut cable entry hole in corner of desk
- 750mm deep top for more workspace
- Hidden cable tidy in legs
- Adjustable feet
- Top available in Natural White or Natural Oak
- Frame and legs in powdercoated black, silver or white
- 5 year warranty

Specifications:

Product Code	Width	Top Depth	Height
RSCWS181275M	1800 x 1200mm	750mm	730mm
RSCWS151575M	1500 x 1500mm	750mm	730mm
RSCWS181575M	1800 x 1500mm	750mm	730mm
RSCWS181875M	1800 x 1800mm	750mm	730mm

Top Finishes:



Base Finishes:



Rapid Span Single Sided Workstations

Features:

- Mix and match choice of 2 top colours and 3 frame colours
- E0 melamine top with pre-cut cable entry hole
- Sturdy powdercoated frame and legs
- Comes with metal perforated modesty panel
- Range of sizes to choose from to suit your space
- 700mm deep top to suit smaller spaces (600mm D return in RSD1818M)
- Adjustable feet
- Top available in Natural White or Beech
- Frame and legs in powdercoated black, silver or white
- 5 year warranty

Specifications:

Product Code	Width	Depth	Height
RSD1277M	1200mm	700mm	730mm
RSD1577M	1500mm	700mm	730mm
RSD1877M	1800mm	700mm	730mm

Top Finishes:



Frame Finishes:



Rapid Span Corner Workstations

Features:

- Mix and match choice of 2 top colours and 3 frame colours
- E0 melamine top with pre-cut cable entry hole
- Sturdy powdercoated frame and legs
- Comes with metal perforated modesty panel
- Range of sizes to choose from to suit your space
- 700mm deep top to suit smaller spaces (600mm D return in RSD1818M)
- Adjustable feet
- Top available in Natural White or Beech
- Frame and legs in powdercoated black, silver or white
- 5 year warranty

Specifications:

Product Code	Width	Depth	Height
RSCWS18127M	1800 x 1200mm	700mm	730mm
RSCWS15157M	1500 x 1500mm	700mm	730mm
RSCWS18157M	1800 x 1500mm	700mm	730mm
RSCWS18187M	1800 x 1800mm	700mm	730mm
RSDR1818M	1800mm x 1800mm (1100 x 600mm D Return)	700mm	730mm

Top Finishes:



Frame Finishes:





Span Cupboard
SP2FD18

Specifications:
Overall Size 900W x 450D x 1800H

- Features:**
- Includes 1 x fixed middle shelf
 - 3 x adjustable shelves
 - Soft close hinges
 - Fully lockable with 2 keys included
 - Master key available for additional cost
 - EO melamine board in Natural White or Beech
 - 5 year warranty

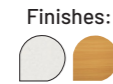

Span Hutch
SPH12 | SPH18

Specifications:
SPH12 1200W x 315D x 1070H
SPH18 1800W x 315D x 1070H

- Features:**
- Includes adjustable shelves
 - Sits on top of a credenza or desk
 - Provides extra storage space
 - EO melamine board in Natural White or Beech
 - 5 year warranty

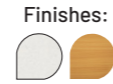

Worker Fixed Pedestal
CDKP1D1F | CDKP3D | CRP3D

Specifications:
CDKP1D1F 1 Drawer, 1 File - 465W x 447D x 454H
CDKP3D 3 Drawers - 465W x 447D x 454H
CRP3D 3 Drawers - 465W x 370D x 454H - Ironstone only

- Features:**
- Can be installed on right or left side of desk
 - EO melamine board in Beech/Ironstone or Ironstone
 - Lockable drawers with 2 keys supplied
 - CRP3D is used for returns and available in Ironstone only
 - 5 year warranty

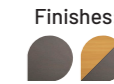

Span Bookcase
SPBC12 | SPBC18

Specifications:
SPBC12 900W x 315D x 1200H
SPBC18 900W x 315D x 1800H

- Features:**
- EO melamine board in Natural White or Beech
 - 1200mm H comes with 3 x adjustable shelves
 - 1800mm H comes with 4 x adjustable shelves
 - 5 year warranty



Span Credenza
SPC12 | SPC18

Specifications:
SPC12 1200W x 450D x 730H
SPC18 1800W x 450D x 730H

- Features:**
- Sliding door credenza
 - Includes 2 x adjustable shelves
 - Fully lockable with 2 keys included
 - EO melamine board in Natural White or Beech
 - 5 year warranty

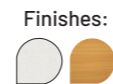

Span Pedestal
SPMP3

Specifications:
Overall Size 465W x 447D x 690H
Weight Capacity 30kg per drawer

- Features:**
- Melamine mobile pedestal on castors
 - 2 x personal drawers and 1 x file drawer
 - Lockable drawers with 2 keys supplied
 - EO melamine board in Natural White or Beech
 - 5 year warranty



Worker Mobile Pedestal
CMP2F | CMP2D1F | CMP4D

Specifications:
CMP2F 2 File Drawers - 465W x 447D x 690H
CMP2D1F 2 Drawers, 1 File Drawer - 465W x 447D x 690H
CMP4D 4 Drawers - 465W x 447D x 690H

- Features:**
- Drawers with metal runners
 - 4 castors with 5th extra castor for stability on file drawer units
 - Lockable drawers with 2 keys supplied
 - EO melamine board in Beech/Ironstone or Ironstone
 - 5 year warranty





CDK96 B/I
Beech / Ironstone



CDK126 B/I
Beech / Ironstone



CDK1875 NW/I
White / Ironstone



CDK189 NO/I
Natural Oak / Ironstone

Rapid Worker Desk

Features:

- E0 melamine board
- CDK96 with 1 x cable entry hole, all other sizes with 2 x cable entry holes
- Built-in modesty panel
- Can be used with fixed pedestals
- Can be used with return to create a larger work surface area
- Available in Natural White/Ironstone, Natural Oak/Ironstone, and Beech/Ironstone
- 5 year warranty

Components:

Product Code	Width	Depth	Height
CDK96	900mm	600mm	730mm
CDK126	1200mm	600mm	730mm
CDK1575	1500mm	750mm	730mm
CDK1875	1800mm	750mm	730mm
CDK189	1800mm	900mm	730mm

Finishes:



Natural Oak / Ironstone



Beech / Ironstone



Natural White / Ironstone

Rapid Worker Desk Return

Features:

- E0 melamine board
- Add to straight desk to create a return
- Creates more desk top space
- Includes modesty panel piece
- Available in Natural White/Ironstone, Natural Oak/Ironstone, and Beech/Ironstone
- 5 year warranty

Components:

Product Code	Width	Depth	Height
CR45	900mm	450mm	730mm
CR6	900mm	600mm	730mm
CR12 (Beech Only)	1200mm	600mm	730mm



Natural Oak / Ironstone
Left-hand return on a CDK1575
(CDK1575 not included)



Natural White / Ironstone
Left-hand return on a CDK189
(CDK189 not included)

Finishes:



Natural Oak / Ironstone



Beech / Ironstone

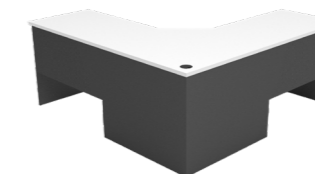

Natural White / Ironstone

Rapid Worker Corner Workstation

Features:

- 3-piece corner workstation in E0 melamine board
- Huge range of sizes to suit your space
- Cable entry hole in corner piece
- Modesty panels with space for cable access
- Available in Natural White/Ironstone, Natural Oak/Ironstone, and Beech/Ironstone
- *CCW1875 available in Beech/Ironstone only
- 5 year warranty

Components:

Product Code	Width	Depth	Height
RWCWS1212	1200 x 1200mm	600mm	730mm
RWCWS1215	1200 x 1500mm	600mm	730mm
RWCWS1218	1200 x 1800mm	600mm	730mm
RWCWS1221	1200 x 2100mm	600mm	730mm
RWCWS1515	1500 x 1500mm	600mm	730mm
RWCWS1815	1800 x 1500mm	600mm	730mm
RWCWS1818	1800 x 1800mm	600mm	730mm
RWCWS2115	2100 x 1500mm	600mm	730mm
RWCWS2118	2100 x 1800mm	600mm	730mm
RWCWS2121	2100 x 2100mm	600mm	730mm
CCW1875*	1800 x 1800mm	750mm	730mm

Finishes:





Worker Cupboard
CSC2FD

Specifications:
Overall Size 900W x 450D x 1800H

- Features:**
- 3 x adjustable shelves
 - 1 x fixed middle shelf
 - Fully lockable doors with 2 keys included
 - Available in Natural White/Ironstone, Natural Oak/Ironstone, and Beech/Ironstone
 - E0 melamine board
 - 5 year warranty

Finishes:



Lockable Wall Unit
CSC2HD

Specifications:
Overall Size 900W x 450D x 1800H

- Features:**
- Lockable half height storage
 - 2 adjustable shelves
 - Supplied with 2 keys
 - Available in Natural White/Ironstone, Natural Oak/Ironstone, and Beech/Ironstone
 - E0 melamine board
 - 5 year warranty

Finishes:



Worker Hutch
CH12 | CH15 | CH18

Specifications:
CH12 1200W x 315D x 1070H
CH15 1500W x 315D x 1070H
CH18 1800W x 315D x 1070H

- Features:**
- 4 shelves in 1200mm and 1500mm sizes
 - 6 shelves in 1800mm size
 - Available in Natural White/Ironstone, Natural Oak/Ironstone, and Beech/Ironstone
 - E0 melamine board
 - 5 year warranty

Finishes:



Worker Desk Hob
CHOB15N | CHOB18N

Specifications:
CHOB15N 1500W x 350D x 400H
CHOB18N 1800W x 350D x 400H

- Features:**
- Creates a reception counter or privacy for your desk
 - Available in Natural White/Ironstone, Natural Oak/Ironstone, and Beech/Ironstone
 - E0 melamine board
 - 5 year warranty

Finishes:



Worker Bookcase
CBC9 | CBC12 | CBC18

Specifications:
CBC9 900W x 315D x 900H
CBC12 900W x 315D x 1200H
CBC18 900W x 315D x 1800H

- Features:**
- 3 x adjustable shelves in 900 and 1200H
 - 4 x adjustable shelves in 1800H
 - Available in Natural White/Ironstone, Natural Oak/Ironstone, and Beech/Ironstone
 - E0 melamine board
 - 5 year warranty

Finishes:



Pigeon Hole Unit
PH20

Specifications:
Overall Size 1040W x 380D x 1040H

- Features:**
- Melamine pigeon hole unit with 20 slots
 - Adjustable shelves
 - E0 melamine board
 - Available in Natural White/Ironstone, Natural Oak/Ironstone, and Beech/Ironstone
 - 5 year warranty

Finishes:



Worker Credenza
CMZ1245 | CMZ1545 | CMZ1845

Specifications:
CMZ1245 1200W x 450D x 730H
CMZ1545 1500W x 450D x 730H
CMZ1845 1800W x 450D x 730H

- Features:**
- 2 x adjustable shelves
 - Fully lockable sliding door with 2 keys
 - Available in Natural White/Ironstone, Natural Oak/Ironstone, and Beech/Ironstone
 - E0 melamine board
 - 5 year warranty

Finishes:



HALO & BOOST WORKSTATION RANGE

Introducing the Rapidline Halo and Boost range. The pinnacle of ergonomic excellence, our flagship models are designed to enhance productivity and comfort in your workspace.

The Halo+ and Boost+ ranges are symbols of unparalleled excellence. Their sleek profiles, customisable features, and intuitive controls redefine the standards for premium workstations. Effortlessly customise your workspace with a user-friendly digital control panel, accompanied by anti-collision technology and whisper-quiet operation.

Complementing Halo+ and Boost+ is Rapidline's exciting new Executive workstation range. Boasting the same modern features, Halo+ and Boost+ Executive includes an integrated side cabinet storage system, making it an exemplar of contemporary corporate comfort.

Leading alongside are the Boost Light and Boost Crank, offering cost-effective height adjustable solutions with premium features. For those looking to combine affordability with quality, Boost Static and Halo Static provide exceptional durability as ergonomic fixed-height workstations.



HS1P1275 NO/BL



HS1PCT1575 NO/WS



HS1PWS1875 NW/BL



HS1PEPCT1875 WWB

HALO STATIC Single Workstations

NEW SCREEN OPTIONS

- Features:**
- Fixed height workstation to match Halo+ range
 - Telescopic frame 1100mm - 1800mm wide
 - Round leg design with adjustable leveling feet
 - 70mm diameter column size, foot size of 700mm
 - Fixed height of 730mm
 - Add-on Shush30+ privacy screens or Eco Panel pinnable screens
 - Optional cable trays for cable tidy
 - Frame finished in white or black satin powdercoat
 - E0 rated melamine tops available in Natural White or Natural Oak
 - Table tops with rigid edging and 50mm D scallop cut out to rear
 - 10 year warranty

Specifications:

Product Code	Screen	Cable Tray	Overall Width	Overall Depth
HS1P1275	No	No	1200mm	750mm
HS1P1575	No	No	1500mm	750mm
HS1P1875	No	No	1800mm	750mm
HS1PCT1275	No	Yes	1200mm	750mm
HS1PCT1575	No	Yes	1500mm	750mm
HS1PCT1875	No	Yes	1800mm	750mm
HS1PWS1275 HS1PEP1275	Yes	No	1200mm	750mm
HS1PWS1575 HS1PEP1575	Yes	No	1500mm	750mm
HS1PWS1875 HS1PEP1875	Yes	No	1800mm	750mm
HS1PWST1275 HS1PEPCT1275	Yes	Yes	1200mm	750mm
HS1PWST1575 HS1PEPCT1575	Yes	Yes	1500mm	750mm
HS1PWST1875 HS1PEPCT1875	Yes	Yes	1800mm	750mm

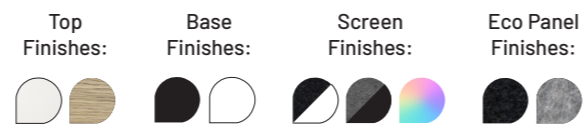

HS2P1275 NO/WS



HS2PCT1575 NW/BL



HS2PWS1575 NO/BL



HS2PEPCT1875 WWG

HALO STATIC Back to Back Workstations

NEW SCREEN OPTIONS

- Features:**
- Maximise your office space with back to back workstations
 - Fixed height double-sided workstation to match the Halo+ range
 - Telescopic frame 1100mm - 1800mm wide
 - Round leg design with adjustable leveling feet
 - 70mm diameter column size, foot size of 700mm
 - Fixed height of 730mm and desk depth of 750mm per user
 - Add-on Shush30+ privacy screens or Eco Panel pinnable screens
 - Optional cable trays for cable tidy
 - Frame finished in white or black satin powdercoat
 - E0 rated melamine tops available in Natural White or Natural Oak
 - 10 year warranty

Specifications:

Product Code	Screen	Cable Tray	Width	Overall Depth
HS2P1275	No	No	1200mm	1500mm
HS2P1575	No	No	1500mm	1500mm
HS2P1875	No	No	1800mm	1500mm
HS2PCT1275	No	Yes	1200mm	1500mm
HS2PCT1575	No	Yes	1500mm	1500mm
HS2PCT1875	No	Yes	1800mm	1500mm
HS2PWS1275 HS2PEP1275	Yes	No	1200mm	1500mm
HS2PWS1575 HS2PEP1575	Yes	No	1500mm	1500mm
HS2PWS1875 HS2PEP1875	Yes	No	1800mm	1500mm
HS2PWST1275 HS2PEPCT1275	Yes	Yes	1200mm	1500mm
HS2PWST1575 HS2PEPCT1575	Yes	Yes	1500mm	1500mm
HS2PWST1875 HS2PEPCT1875	Yes	Yes	1800mm	1500mm

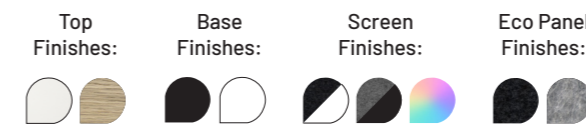

HSCNR1P1515 NW/BL



HSCNRCT1P1815 NO/WS



HSCNRWS1P1818 NW/WS



HSCNREPCT1P1818 OBB

HALO STATIC Corner Workstations

NEW SCREEN OPTIONS

- Features:**
- Fixed height corner workstation to match the Halo+ range
 - Telescopic frame 1040mm - 2150mm wide
 - Round leg design with adjustable leveling feet
 - 70mm diameter column size, foot size of 700mm
 - Fixed height of 730mm
 - Add-on Shush30+ privacy screens or Eco Panel pinnable screens
 - Optional cable trays for cable tidy
 - Frame finished in white or black satin powdercoat
 - E0 rated melamine tops available in Natural White or Natural Oak
 - 10 year warranty

Specifications:

Product Code	Screen	Cable Tray	Overall Size
HSCNR1P1515	No	No	1500 x 1500mm
HSCNR1P1815	No	No	1800 x 1500mm
HSCNR1P1818	No	No	1800 x 1800mm
HSCNRCT1P1515	No	Yes	1500 x 1500mm
HSCNRCT1P1815	No	Yes	1800 x 1500mm
HSCNRCT1P1818	No	Yes	1800 x 1800mm
HSCNRWS1P1515 HSCNREP1P1515	Yes	No	1500 x 1500mm
HSCNRWS1P1815 HSCNREP1P1815	Yes	No	1800 x 1500mm
HSCNRWS1P1818 HSCNREP1P1818	Yes	No	1800 x 1800mm
HSCNRWST1P1515 HSCNREPCT1P1515	Yes	Yes	1500 x 1500mm
HSCNRWST1P1815 HSCNREPCT1P1815	Yes	Yes	1800 x 1500mm
HSCNRWST1P1818 HSCNREPCT1P1818	Yes	Yes	1800 x 1800mm





H+1P1275 NO/BL



H+1PCT1575 NO/WS



H+1PWS1875 NW/WS



H+1PEPCT1875 WBG

HALO+ Single Workstation

Features:

- Dual motor, round leg with a column size of 70mm diameter
- Digital control panel with 3 pre-set positions, LED display panel, keypad safety lock & reminder alarm setting
- Anti-collision and anti-tilt technology, noise emission of less than 50DB
- 120kg weight lifting capacity, with a max speed of 38mm per second
- Adjustable leveling feet with a foot size of 700mm
- Add-on Shush30+ privacy screens or Eco Panel pinnable screens
- Optional cable trays for cable tidy
- Adjustable height of 620-1270mm, and overall height of 1330mm with screens
- Frame finished in white or black satin powdercoat
- E0 rated melamine tops available in Natural White or Natural Oak
- 10 year warranty

Specifications:

Product Code	Screen	Cable Tray	Overall Width	Overall Depth
H+1P1275	No	No	1200mm	750mm
H+1P1575	No	No	1500mm	750mm
H+1P1875	No	No	1800mm	750mm
H+1PCT1275	No	Yes	1200mm	750mm
H+1PCT1575	No	Yes	1500mm	750mm
H+1PCT1875	No	Yes	1800mm	750mm
H+1PWS1275 H+1PEP1275	Yes	No	1200mm	750mm
H+1PWS1575 H+1PEP1575	Yes	No	1500mm	750mm
H+1PWS1875 H+1PEP1875	Yes	No	1800mm	750mm
H+1PWST1275 H+1PEPCT1275	Yes	Yes	1200mm	750mm
H+1PWST1575 H+1PEPCT1575	Yes	Yes	1500mm	750mm
H+1PWST1875 H+1PEPCT1875	Yes	Yes	1800mm	750mm

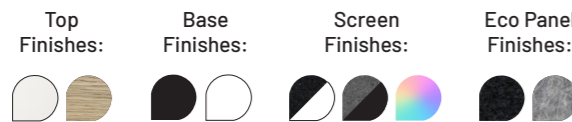

NEW SCREEN OPTIONS



H+2P1275 NO/WS



H+2PCT1275 NW/BL



H+2PWS1575 NO/BL



H+2PEPCT1875 WWB

HALO+ Back to Back Workstations

Features:

- All of the features of the HALO+ Single Sided Workstations and more
- Maximise your office space with back to back workstations
- Adjustable height of 620-1270mm, and overall height of 1330mm with screens
- Desk depth of 750mm per user
- 10 year warranty

Specifications:

Product Code	Screen	Cable Tray	Overall Width	Overall Depth
H+2P1275	No	No	1200mm	1500mm
H+2P1575	No	No	1500mm	1500mm
H+2P1875	No	No	1800mm	1500mm
H+2PCT1275	No	Yes	1200mm	1500mm
H+2PCT1575	No	Yes	1500mm	1500mm
H+2PCT1875	No	Yes	1800mm	1500mm
H+2PWS1275 H+2PEP1275	Yes	No	1200mm	1500mm
H+2PWS1575 H+2PEP1575	Yes	No	1500mm	1500mm
H+2PWS1875 H+2PEP1875	Yes	No	1800mm	1500mm
H+2PWST1275 H+2PEPCT1275	Yes	Yes	1200mm	1500mm
H+2PWST1575 H+2PEPCT1575	Yes	Yes	1500mm	1500mm
H+2PWST1875 H+2PEPCT1875	Yes	Yes	1800mm	1500mm



NEW SCREEN OPTIONS



H+CNRIP1515 NW/WS



H+CNRCTIP1515 NO/BL



H+CNRWSIP1818 NW/BL



H+CNREP1818 OWB

HALO+ Corner Workstations

Features:

- Triple motor, round leg with a column size of 70mm diameter
- Digital control panel with 3 pre-set positions, LED display panel, keypad safety lock and reminder alarm setting
- Anti-collision and anti-tilt technology, noise emission of less than 50DB
- 140kg weight lifting capacity, with a max speed of 38mm per second
- Adjustable leveling feet with a foot size of 700mm
- Add-on Shush30+ privacy screens or Eco Panel pinnable screens
- Optional cable trays for cable tidy
- Adjustable height of 620-1270mm, and overall height of 1330mm with screens
- Frame finished in white or black satin powdercoat
- Desk depth of 750mm with tops available in Natural White or Natural Oak
- 10 year warranty

Specifications:

Product Code	Screen	Cable Tray	Overall Size
H+CNRIP1515	No	No	1500 x 1500mm
H+CNRIP1815	No	No	1800 x 1500mm
H+CNRIP1818	No	No	1800 x 1800mm
H+CNRCTIP1515	No	Yes	1500 x 1500mm
H+CNRCTIP1815	No	Yes	1800 x 1500mm
H+CNRCTIP1818	No	Yes	1800 x 1800mm
H+CNRWSIP1515 H+CNREP1515	Yes	No	1500 x 1500mm
H+CNRWSIP1815 H+CNREP1815	Yes	No	1800 x 1500mm
H+CNRWSIP1818 H+CNREP1818	Yes	No	1800 x 1800mm
H+CNRWSTIP1515 H+CNREPCTIP1515	Yes	Yes	1500 x 1500mm
H+CNRWSTIP1815 H+CNREPCTIP1815	Yes	Yes	1800 x 1500mm
H+CNRWSTIP1818 H+CNREPCTIP1818	Yes	Yes	1800 x 1800mm



NEW SCREEN OPTIONS



HALO+ Desk and Return

Features:

- Add a return frame and top to any HALO+ single desk to create a 2-piece workstation with a cockpit style corner
- Suits rectangular return table tops and radial 1-piece corner workstation tops with overall return edge size of 1450mm - 2150mm
- Round leg with a column size of 70mm diameter
- Foot size of 500mm
- Desk mounting top plate size of 500mm
- 160kg weight lifting capacity
- Digital control panel with 3 pre-set positions, LED display panel, keypad safety lock & reminder alarm setting
- Adjusts at 38mm per second
- Anti-collision and anti-tilt technology, noise emission of less than 50DB
- Telescopic frame 1040mm - 2150mm wide
- Adjustable leveling feet
- Return top available in Natural White or Natural Oak
- Add-on Shush30+ privacy screens or Eco Panel pinnable screens
- Optional cable trays for cable tidy
- Frame finished in white or black satin powdercoat
- Optional accessories: battery pack, cable snake, and cable tray bridge
- 10 year warranty

Specifications:

Product	Code	Width	Depth	Height
Return frame	HP-RF	1040 - 2150mm	700mm	620 - 1270mm
Return top	T116	1100mm	600mm	25mm

Top Finishes:



Base Finishes:





BOOST & HALO Executive Side Cabinet
EXDSC185-LEF | EXDSC185-RIG

Specifications:
Overall Size 1800W x 500D x 520H

- Features:**
- Executive desk side cabinet for Boost+ and Halo+ range
 - Choice of left or right-hand orientation
 - Natural Oak carcass with Natural White drawer and door fronts
 - Drawers fitted with cyberlock 4 digit manual combination lock
 - 2x pull out drawers, 1x double swing door cupboard, 1x single swing door cupboard with adjustable shelf
 - Soft close hinges and runners
 - 5 year warranty

Finish:



EXDSC185-LEF NO/NW



EXDSC185-RIG NO/NW



HELE187 NO/BL-NOW



HERI187 NO/WS-NOW



HELEMP189 NW/WS-NOW

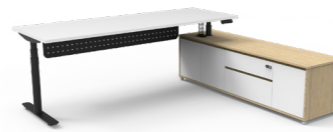

HERIMP217 NW/BL-NOW

HALO+ Executive Workstations

Features:

- A two-piece, height adjustable workspace with storage, available in left or right-hand configurations to suit any office layout
- Optional perforated modesty panel for privacy when visible from the front
- Digital control panel with 3 pre-set positions, LED display panel, keypad safety lock and reminder alarm setting
- 120kg lifting capacity and 1100mm - 1800mm wide telescopic frame
- 2 x pull out drawers, 1 x double swing door cupboard, and 1 x single swing door cupboard with adjustable shelf
- Drawers fitted with cyberlock 4-digit manual combination lock
- Frame finished in black or white powdercoat
- E0 rated melamine top in Natural Oak or Natural White with no cable entry holes or scallops
- Natural Oak side cabinet with Natural White drawers and doors
- 10 year warranty

Specifications:

Product Code	Left/Right	Modesty Panel	Overall Size	Desk Height
HELE187	Left	No	2020 x 1936mm	620 - 1270mm
HELE189	Left	No	2020 x 2011mm	620 - 1270mm
HELE217	Left	No	2270 x 1936mm	620 - 1270mm
HELEMP187	Left	Yes	2020 x 1936mm	620 - 1270mm
HELEMP189	Left	Yes	2020 x 2011mm	620 - 1270mm
HELEMP217	Left	Yes	2270 x 1936mm	620 - 1270mm
HERI187	Right	No	2020 x 1936mm	620 - 1270mm
HERI189	Right	No	2020 x 2011mm	620 - 1270mm
HERI217	Right	No	2270 x 1936mm	620 - 1270mm
HERIMP187	Right	Yes	2020 x 1936mm	620 - 1270mm
HERIMP189	Right	Yes	2020 x 2011mm	620 - 1270mm
HERIMP217	Right	Yes	2270 x 1936mm	620 - 1270mm

Top Finish:



Base Finishes:



*Frame only



BELE187 NO/BL-NOW



BERI187 NO/WS-NOW



BELEMP189 NW/WS-NOW

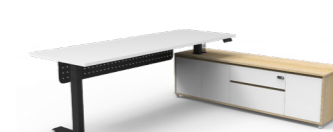

BERIMP217 NW/BL-NOW

BOOST+ Executive Workstations

Features:

- A two-piece, height adjustable workspace with storage, available in left or right-hand configurations to suit any office layout
- Optional perforated modesty panel for privacy when visible from the front
- Digital control panel with 3 pre-set positions, LED display panel, keypad safety lock and reminder alarm setting
- 120kg lifting capacity and 1100mm - 1800mm wide telescopic frame
- 2 x pull out drawers, 1 x double swing door cupboard, and 1x single swing door cupboard with adjustable shelf
- Drawers fitted with cyberlock 4-digit manual combination lock
- Frame finished in black or white powdercoat
- E0 rated melamine top in Natural Oak or Natural White with no cable entry holes or scallops
- Natural Oak side cabinet with Natural White drawers and doors
- 10 year warranty

Specifications:

Product Code	Left/Right	Modesty Panel	Overall Size	Desk Height
BELE187	Left	No	2020 x 1936mm	620 - 1270mm
BELE189	Left	No	2020 x 2011mm	620 - 1270mm
BELE217	Left	No	2270 x 1936mm	620 - 1270mm
BELEMP187	Left	Yes	2020 x 1936mm	620 - 1270mm
BELEMP189	Left	Yes	2020 x 2011mm	620 - 1270mm
BELEMP217	Left	Yes	2270 x 1936mm	620 - 1270mm
BERI187	Right	No	2020 x 1936mm	620 - 1270mm
BERI189	Right	No	2020 x 2011mm	620 - 1270mm
BERI217	Right	No	2270 x 1936mm	620 - 1270mm
BERIMP187	Right	Yes	2020 x 1936mm	620 - 1270mm
BERIMP189	Right	Yes	2020 x 2011mm	620 - 1270mm
BERIMP217	Right	Yes	2270 x 1936mm	620 - 1270mm

Top Finish:



Base Finishes:



*Frame only



B+1P1275 NW/BL



B+1PCT1275 NO/BL



B+1PWS1575 NO/WS



B+1PEPCT1875 WWG

BOOST+ Single Workstations

Features:

- LED digital controller with 3 pre-set programmable heights and easy to use up & down arrows
- 120kg weight lifting capacity, adjusts at 38mm per second
- Anti-collision and anti-tilt safety features
- Dual motor with 3 stage motorised legs with low noise emissions
- Keypad safety lock and reminder alarm setting
- Add-on Shush30+ privacy screens or Eco Panel pinnable screens
- Optional cable trays for cable tidy
- Adjustable height of 620-1270mm, and overall height of 1330mm with screens
- Frame finished in white or black satin powdercoat
- E0 rated melamine tops available in Natural White or Natural Oak
- 10 year warranty

Specifications:

Product Code	Screen	Cable Tray	Overall Width	Overall Depth
B+1P1275	No	No	1200mm	750mm
B+1P1575	No	No	1500mm	750mm
B+1P1875	No	No	1800mm	750mm
B+1PCT1275	No	Yes	1200mm	750mm
B+1PCT1575	No	Yes	1500mm	750mm
B+1PCT1875	No	Yes	1800mm	750mm
B+1PWS1275 B+1PEP1275	Yes	No	1200mm	750mm
B+1PWS1575 B+1PEP1575	Yes	No	1500mm	750mm
B+1PWS1875 B+1PEP1875	Yes	No	1800mm	750mm
B+1PWSCT1275 B+1PEPCT1275	Yes	Yes	1200mm	750mm
B+1PWSCT1575 B+1PEPCT1575	Yes	Yes	1500mm	750mm
B+1PWSCT1875 B+1PEPCT1875	Yes	Yes	1800mm	750mm



NEW SCREEN OPTIONS



B+2P1275 NW/WS



B+2PCT1575 NO/WS



B+2PWS1875 NW/BL



B+2PEPCT1875 OBG

BOOST+ Back to Back Workstations

Features:

- All of the features of the BOOST+ Single Sided Workstations and more
- Maximise your office space with back to back workstations
- Adjustable height of 620-1270mm, and overall height of 1330mm with screens
- Desk depth of 750mm per user
- 10 year warranty

Specifications:

Product Code	Screen	Cable Tray	Overall Width	Overall Depth
B+2P1275	No	No	1200mm	1500mm
B+2P1575	No	No	1500mm	1500mm
B+2P1875	No	No	1800mm	1500mm
B+2PCT1275	No	Yes	1200mm	1500mm
B+2PCT1575	No	Yes	1500mm	1500mm
B+2PCT1875	No	Yes	1800mm	1500mm
B+2PWS1275 B+2PEP1275	Yes	No	1200mm	1500mm
B+2PWS1575 B+2PEP1575	Yes	No	1500mm	1500mm
B+2PWS1875 B+2PEP1875	Yes	No	1800mm	1500mm
B+2PWSCT1275 B+2PEPCT1275	Yes	Yes	1200mm	1500mm
B+2PWSCT1575 B+2PEPCT1575	Yes	Yes	1500mm	1500mm
B+2PWSCT1875 B+2PEPCT1875	Yes	Yes	1800mm	1500mm

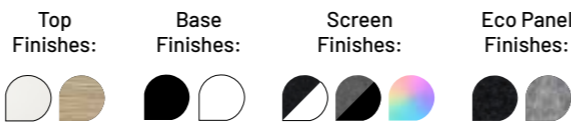

NEW SCREEN OPTIONS



B+CNR1P1515 NW/BL



B+CNRCT1P1815 NO/BL



B+CNRWS1P1818 NO/WS



B+CNRREPCT1P1818 WWB

BOOST+ Corner Workstations

Features:

- LED digital controller with 3 pre-set programmable heights and easy to use up & down arrows
- 140kg weight lifting capacity, adjusts at 38mm per second
- Anti-collision and anti-tilt safety features
- Triple motor with 3-stage motorised legs with low noise emissions
- Keypad safety lock and reminder alarm setting
- Add-on Shush30+ privacy screens or Eco Panel pinnable screens
- Optional cable trays for cable tidy
- Adjustable height of 620-1270mm, and overall height of 1330mm with screens
- Frame finished in white or black satin powdercoat
- Desk depth of 750mm with tops available in Natural White or Natural Oak
- 10 year warranty

Specifications:

Product Code	Screen	Cable Tray	Overall Size
B+CNR1P1515	No	No	1500 x 1500mm
B+CNR1P1815	No	Yes	1800 x 1500mm
B+CNR1P1818	Yes	No	1800 x 1800mm
B+CNRCT1P1515	Yes	Yes	1500 x 1500mm
B+CNRCT1P1815	No	No	1800 x 1500mm
B+CNRCT1P1818	No	Yes	1800 x 1800mm
B+CNRWS1P1515 B+CNREP1P1515	Yes	No	1500 x 1500mm
B+CNRWS1P1815 B+CNREP1P1815	Yes	Yes	1800 x 1500mm
B+CNRWS1P1818 B+CNREP1P1818	No	No	1800 x 1800mm
B+CNRWSC1P1515 B+CNREPCT1P1515	No	Yes	1500 x 1500mm
B+CNRWSC1P1815 B+CNREPCT1P1815	Yes	No	1800 x 1500mm
B+CNRWSC1P1818 B+CNREPCT1P1818	Yes	Yes	1800 x 1800mm



NEW SCREEN OPTIONS



BOOST+ Desk and Return

Features:

- Add a return frame and top to any BOOST+ single desk to create a 2-piece workstation with a cockpit style corner
- Suits rectangular return table tops and radial 1-piece corner workstation tops with overall return edge size of 1450mm - 2150mm
- Column size of 90mm x 60mm
- Foot size of 500mm
- Desk mounting top plate size of 500mm
- 140kg weight lifting capacity
- Digital control panel with 3 pre-set positions, LED display panel, keypad safety lock & reminder alarm setting
- Adjusts at 38mm per second
- Anti-collision and anti-tilt safety features
- Telescopic frame 1040mm - 2150mm wide
- Adjustable leveling feet
- Return top available in Natural White or Natural Oak
- Add-on Shush30+ privacy screens or Eco Panel pinnable screens
- Frame finished in white or black satin powdercoat
- Optional accessories: battery pack, cable snake, and cable tray bridge
- 10 year warranty

Specifications:

Product	Code	Width	Depth	Height
Return frame	B2-RF	1040 - 2150mm	-	620 - 1270mm
Return top	T116	1100mm	600mm	25mm

Top Finishes:



Base Finishes:





BL1IP175 NW/BL



BL1IPCT1875 NO/WS



BL1IPWS1575 NW/WS



BL1IPEPCT1875 OBB

BOOST LIGHT Single Workstation

Features:

- Digital control panel with 3 pre-set positions, LED display panel, keypad safety lock & reminder alarm setting
- Single motor underframe finished in black or white powdercoat
- Anti-collision technology, noise emission of less than 50DB
- Column size of 90mm x 60mm, desk mounting top plate size of 500mm
- Lifting capacity of 80kg with a max speed of 25mm per second
- 700mm wide foot size with adjustable leveling feet
- E0 rated melamine tops available in Natural White or Natural Oak
- Add-on Shush30+ privacy screens or Eco Panel pinnable screens
- Adjustable height of 620-1270mm, and overall height of 1330mm with screens
- Optional cable trays for cable tidy
- 10 year warranty

Specifications:

Product Code	Screen	Cable Tray	Width	Overall Depth
BL1IP1275	No	No	1200mm	750mm
BL1IP1575	No	No	1500mm	750mm
BL1IP1875	No	No	1800mm	750mm
BL1IPCT1275	No	Yes	1200mm	750mm
BL1IPCT1575	No	Yes	1500mm	750mm
BL1IPCT1875	No	Yes	1800mm	750mm
BL1IPWS1275 BL1IPEP1275	Yes	No	1200mm	750mm
BL1IPWS1575 BL1IPEP1575	Yes	No	1500mm	750mm
BL1IPWS1875 BL1IPEP1875	Yes	No	1800mm	750mm
BL1IPWSCT1275 BL1IPEPCT1275	Yes	Yes	1200mm	750mm
BL1IPWSCT1575 BL1IPEPCT1575	Yes	Yes	1500mm	750mm
BL1IPWSCT1875 BL1IPEPCT1875	Yes	Yes	1800mm	750mm

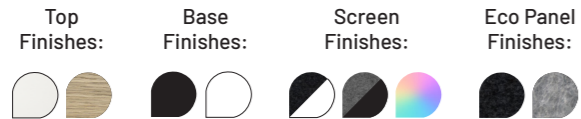

NEW SCREEN OPTIONS



BC1P1575 NO/BL



BC1PCT1875 NW/BL



BC1PWS1575 NO/WS



BC1PEPCT1875 WWG

BOOST CRANK Single Workstations

Features:

- Manual height adjustable workstation to match Boost+ range
- E0 rated melamine tops available in Natural White or Natural Oak
- Table tops with rigid edging and 50mm D scallop cut out to rear
- Underframe finished in black or white powdercoat
- 120kg weight lifting capacity
- Max speed of 15mm per second (10mm per full turn circle)
- Foot size of 700mm with adjustable leveling feet
- Add-on Shush30+ privacy screens or Eco Panel pinnable screens
- Adjustable height of 705-1155mm, and overall height of 1330mm with screens
- Optional cable trays for cable tidy
- 10 year warranty

Specifications:

Product Code	Screen	Cable Tray	Overall Width	Overall Depth
BC1P1275	No	No	1200mm	750mm
BC1P1575	No	No	1500mm	750mm
BC1P1875	No	No	1800mm	750mm
BC1PCT1275	No	Yes	1200mm	750mm
BC1PCT1575	No	Yes	1500mm	750mm
BC1PCT1875	No	Yes	1800mm	750mm
BC1PWS1275 BC1PWS1275	Yes	No	1200mm	750mm
BC1PWS1575 BC1PWS1575	Yes	No	1500mm	750mm
BC1PWS1875 BC1PWS1875	Yes	No	1800mm	750mm
BC1PWSCT1275 BC1PEPCT1275	Yes	Yes	1200mm	750mm
BC1PWSCT1575 BC1PEPCT1575	Yes	Yes	1500mm	750mm
BC1PWSCT1875 BC1PEPCT1875	Yes	Yes	1800mm	750mm



NEW SCREEN OPTIONS



BC2P1575 NO/BL



BC2PCT1575 NW/BL



BC2PWS1875 NO/WS



BC2PEPCT1875 WWB

BOOST CRANK Back to Back Workstations

Features:

- All of the features of the Boost Crank Single Sided workstation and more
- Maximise your office space with back to back workstations
- Add-on Shush30+ privacy screens or Eco Panel pinnable screens
- Adjustable height of 705-1155mm, and overall height of 1330mm with screens
- Desk depth of 750mm per user
- Underframe finished in black or white powdercoat
- Optional cable trays for cable tidy
- 10 year warranty

Specifications:

Product Code	Screen	Cable Tray	Overall Width	Overall Depth
BC2P1275	No	No	1200mm	1500mm
BC2P1575	No	No	1500mm	1500mm
BC2P1875	No	No	1800mm	1500mm
BC2PCT1275	No	Yes	1200mm	1500mm
BC2PCT1575	No	Yes	1500mm	1500mm
BC2PCT1875	No	Yes	1800mm	1500mm
BC2PWS1275 BC2PEP1275	Yes	No	1200mm	1500mm
BC2PWS1575 BC2PEP1575	Yes	No	1500mm	1500mm
BC2PWS1875 BC2PEP1875	Yes	No	1800mm	1500mm
BC2PWSCT1275 BC2PWSCT1275	Yes	Yes	1200mm	1500mm
BC2PWSCT1575 BC2PWSCT1575	Yes	Yes	1500mm	1500mm
BC2PWSCT1875 BC2PEPCT1875	Yes	Yes	1800mm	1500mm



NEW SCREEN OPTIONS



BCCNRIP1515 NO/BL



BCCNRCTIP1818 NW/BL



BCCNRWSIP1818 NW/WS



BCCNREPCTIP1818 OWG

BOOST CRANK Corner Workstations

Features:

- Manual height adjustable workstation to match Boost+ range
- E0 rated 25mm thick table top with rigid edging and 80mm diameter cable entry with cover
- Foot size of 700mm for main desk and 500mm for return frame
- Underframe finished in black or white powdercoat
- 140kg weight lifting capacity
- Max speed of 15mm per second (10mm per full turn circle)
- Add-on Shush30+ privacy screens or Eco Panel pinnable screens
- Adjustable height of 705-1155mm, and overall height of 1330mm with screens
- Optional cable trays for cable tidy
- 10 year warranty

Specifications:

Product Code	Screen	Cable Tray	Overall Size
BCCNRIP1515	No	No	1500x1500mm
BCCNRIP1815	No	No	1800x1500mm
BCCNRIP1818	No	No	1800x1800mm
BCCNRCTIP1515	No	Yes	1500x1500mm
BCCNRCTIP1815	No	Yes	1800x1500mm
BCCNRCTIP1818	No	Yes	1800x1800mm
BCCNRWSIP1515 BCCNREP1515	Yes	No	1500x1500mm
BCCNRWSIP1815 BCCNREP1815	Yes	No	1800x1500mm
BCCNRWSIP1818 BCCNREP1818	Yes	No	1800x1800mm
BCCNRWSCTIP1515 BCCNREPCTIP1515	Yes	Yes	1500x1500mm
BCCNRWSCTIP1815 BCCNREPCTIP1815	Yes	Yes	1800x1500mm
BCCNRWSCTIP1818 BCCNREPCTIP1818	Yes	Yes	1800x1800mm



NEW SCREEN OPTIONS



SB1P1275 NW/WS



SB1PCT1875 NO/BL



SB1PWS1575 NO/WS



SB1PEPCT1875 WBG

BOOST STATIC Single Workstations

Features:

- Fixed height workstation to match Boost+ range
- Telescopic frame 1100mm - 1800mm wide
- Column size of 90mm x 60mm, foot size of 700mm
- Fixed height of 730mm
- Adjustable leveling feet
- Add-on Shush30+ privacy screens or Eco Panel pinnable screens
- Optional cable trays for cable tidy
- Frame finished in white or black satin powdercoat
- E0 rated melamine tops available in Natural White or Natural Oak
- Table tops with rigid edging and 50mm D scallop cut out to rear
- 10 year warranty

Specifications:

Product Code	Screen	Cable Tray	Width	Depth
SB1P1275	No	No	1200mm	750mm
SB1P1575	No	No	1500mm	750mm
SB1P1875	No	No	1800mm	750mm
SB1PCT1275	No	Yes	1200mm	750mm
SB1PCT1575	No	Yes	1500mm	750mm
SB1PCT1875	No	Yes	1800mm	750mm
SB1PWS1275 SB1PEP1275	Yes	No	1200mm	750mm
SB1PWS1575 SB1PEP1575	Yes	No	1500mm	750mm
SB1PWS1875 SB1PEP1875	Yes	No	1800mm	750mm
SB1PWSCT1275 SB1PEPCT1275	Yes	Yes	1200mm	750mm
SB1PWSCT1575 SB1PEPCT1575	Yes	Yes	1500mm	750mm
SB1PWSCT1875 SB1PEPCT1875	Yes	Yes	1800mm	750mm



NEW SCREEN OPTIONS



SB2P1275 NO/WS



SB2PCT1275 NW/BL



SB2PWS1575 NO/BL



SB2PEPCT1875 WBG

BOOST STATIC Back to Back Workstations

Features:

- Fixed height workstation to match Boost+ range
- Maximise your office space with back to back workstations
- Telescopic frame 1100mm - 1800mm wide
- Column size of 90mm x 60mm, foot size of 700mm
- Fixed height of 730mm
- Desk depth of 750mm per user
- Add-on Shush30+ privacy screens or Eco Panel pinnable screens
- Optional cable trays for cable tidy
- Frame finished in white or black satin powdercoat
- E0 rated melamine tops available in Natural White or Natural Oak
- 10 year warranty

Specifications:

Product Code	Screen	Cable Tray	Width	Overall Depth
SB2P1275	No	No	1200mm	1500mm
SB2P1575	No	No	1500mm	1500mm
SB2P1875	No	No	1800mm	1500mm
SB2PCT1275	No	Yes	1200mm	1500mm
SB2PCT1575	No	Yes	1500mm	1500mm
SB2PCT1875	No	Yes	1800mm	1500mm
SB2PWS1275 SB2PEP1275	Yes	No	1200mm	1500mm
SB2PWS1575 SB2PEP1575	Yes	No	1500mm	1500mm
SB2PWS1875 SB2PEP1875	Yes	No	1800mm	1500mm
SB2PWSCT1275 SB2PEPCT1275	Yes	Yes	1200mm	1500mm
SB2PWSCT1575 SB2PEPCT1575	Yes	Yes	1500mm	1500mm
SB2PWSCT1875 SB2PEPCT1875	Yes	Yes	1800mm	1500mm



NEW SCREEN OPTIONS



SBCNRIP1515 NO/BL



SBCNRCTIP1515 NW/WS



SBCNRWSIP1815 NW/BL



SBCNREPCTIP1818 OWB

BOOST STATIC Corner Workstations

Features:

- Fixed height corner workstation to match Boost+ range
- Telescopic frame 1040mm - 2150mm wide
- Column size of 90mm x 60mm, foot size of 700mm
- Fixed height of 730mm
- Add-on Shush30+ privacy screens or Eco Panel pinnable screens
- Optional cable trays for cable tidy
- Frame finished in white or black satin powdercoat
- Adjustable leveling feet
- E0 rated melamine tops available in Natural White or Natural Oak
- 10 year warranty

Specifications:

Product Code	Screen	Cable Tray	Overall Size
SBCNRIP1515	No	No	1500 x 1500mm
SBCNRIP1815	No	No	1800 x 1500mm
SBCNRIP1818	No	No	1800 x 1800mm
SBCNRCTIP1515	No	Yes	1500 x 1500mm
SBCNRCTIP1815	No	Yes	1800 x 1500mm
SBCNRCTIP1818	No	Yes	1800 x 1800mm
SBCNRWSIP1515 SBCNREP1515	Yes	No	1500 x 1500mm
SBCNRWSIP1815 SBCNREP1815	Yes	No	1800 x 1500mm
SBCNRWSIP1818 SBCNREP1818	Yes	No	1800 x 1800mm
SBCNRWSCTIP1515 SBCNREPC1515	Yes	Yes	1500 x 1500mm
SBCNRWSCTIP1815 SBCNREPC1815	Yes	Yes	1800 x 1500mm
SBCNRWSCTIP1818 SBCNREPC1818	Yes	Yes	1800 x 1800mm



NEW SCREEN OPTIONS



Slide Out Drawer SLDRAWER BK | SLDRAWER WS

Specifications:

Overall Size	493W x 293D x 77H
Drawer Size	405W x 275D

Features:

- Mounts to underside of any workstation table top
- Single slide out workstation drawer
- Lockable
- Available in black or white
- Includes acoustic panel drawer liner
- 10 year warranty

Finishes:



NEW

Arch Perforated Modesty Panel PSM1000 | PSM1300 | PSM1600

Specifications:

PSM1000	1000W x 200 x 300H
PSM1300	1300W x 200 x 300H
PSM1600	1600W x 200 x 300H

Features:

- Provides privacy by attaching to the underside of workstations
- Available in black or white powdercoat to suit workstation frame
- Use with Deluxe Infinity, Boost and Halo workstations
- 1.5mm steel gauge
- 10 year warranty

Finishes:





Cable Dump Tray
BH-SCDT BL | BH-SCDT WS

NEW

Specifications:

Overall Size 900-1400W x 95D x 25H
Cable entry holes 50mm Diameter

Features:

- Fits to Boost & Halo frames
- Use to tidy control box cables within frame as required
- Available in black or white powdercoat
- 10 year warranty

Finishes:



Single Cable Tray
B2-SSCT12 | B2-SSCT15 | B2-SSCT18

Specifications:

B2-SSCT12 1010W x 175D x 90H
B2-SSCT15 1310W x 175D x 90H
B2-SSCT18 1610W x 175D x 90H

Features:

- Internal segregation for power and data
- External and internal power and data punch out provisions
- Four external punchouts at 230mm x 42mm and two internal punchouts at 230mm x 42mm
- Solid steel cable tray lid with 2 x access holes for cable snakes
- 10 year warranty

Finishes:



Back to Back Cable Tray
B2-B2BCT12 | B2-B2BCT15 | B2-B2BCT18

Specifications:

B2-B2BCT12 1010W x 350D x 90H
B2-B2BCT15 1310W x 350D x 90H
B2-B2BCT18 1610W x 350D x 90H

Features:

- Internal segregation for power and data
- External and internal power and data punch out provisions
- Four external punchouts at 230mm x 42mm and two internal punchouts at 230mm x 42mm
- Solid steel cable tray lid with 2 x access holes for cable snakes
- 10 year warranty

Finishes:

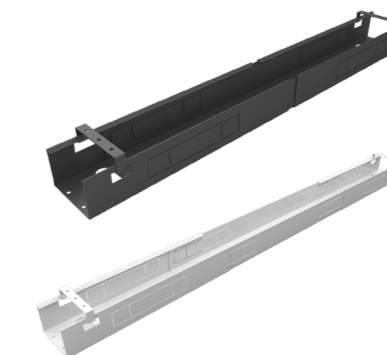

Telescopic Desk Mount Cable Tray
TUDMT1117

Specifications:

Overall Size 1100-1700W x 122D x 100H

Features:

- Telescopic under desk mount cable tray
- Finished in Black or White powdercoat
- Provisions for up to 4 x 4GPO modules or 8 x data
- 10 year warranty

Finishes:



Umbilical Hub
BH-UMBSIN | BH-UMBDOU

NEW

Specifications:

BH-UMBSIN 130W x 175D x 92.5H for single frame
BH-UMBDOU 212W x 350D x 92.5H for back to back frame
Entry hole 80mm Diameter

Features:

- Compatible with CMS Cirqlate & Axess Umbilicals, as well as CMS Totem Solid Power Poles
- Use with Boost & Halo frames
- Available for single desks and back to back desks
- Magnetic access lid
- 10 year warranty

Finishes:



Telescopic Cable Tray - Single
SS-TCT

Specifications:

Overall Size 1300 - 1900W x 175D x 90H

Features:

- Suits workstation tops with a width between 1500-2100mm
- Internal segregation for power and data
- External and internal power and data punch out provisions
- Four external punchouts at 230mm x 42mm and four internal punchouts at 230mm x 42mm
- Solid steel cable tray lid with 2 x access holes for cable snakes
- 10 year warranty

Finishes:



Telescopic Cable Tray - Double
B2B-TELCT1319

Specifications:

Overall Size 1300-1900W x 350D x 90H

Features:

- Suits workstation tops with a width between 1500-2100mm
- Internal segregation for power and data
- External and internal power and data punch out provisions
- Four external punchouts at 230mm x 42mm and four internal punchouts at 230mm x 42mm
- Solid steel cable tray lid with 2 x access holes for cable snakes
- 10 year warranty

Finishes:



Cable Tray Bridge
B2-SSBR | B2-B2BBR

Specifications:

B2-SSBR 100W x 175D x 94H
B2-B2BBR 100W x 350D x 94H

Features:

- Allows 30mm gap between users
- Cable tray cover to go between two single sided workstation frames or two back to back workstation frames
- 10 year warranty

Finishes:





Cable Snake
BH-HDSNAKE

Specifications:
Overall Size 70W x 40D x 1200H

- Features:**
- Flexible cable snakes
 - 4 x segregation channels per snake
 - 1 piece per carton
 - Available in black or white to match workstation frame
 - 3 year warranty

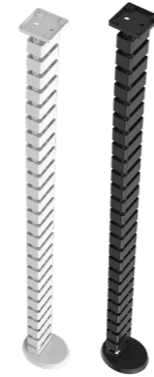

Floor to Under Desk Snake
BH-1300SNAKE

Specifications:
Overall Size 67W x 35D x 1300H

- Features:**
- 4 x segregation channels per snake
 - One end fitted with weighted foot and one end fitted with provisions to be screwed to underside of desktop
 - 1 piece per carton
 - Screws for under desk fitting not included
 - Finished in Black or White plastic
 - 3 year warranty

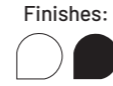

Shush30+ Joining Poles
SHSJP900 | SHSJP1330

Specifications:
Overall Size 30W x 30D
Available Heights 900mm and 1330mm

- Features:**
- 360° joining poles
 - Includes all hooks and cover plates
 - Adjustable leveling foot included
 - 5 year warranty

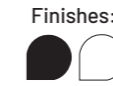

Bluetooth Control Box
B2-BTCB

Specifications:
Overall Size 80W x 150D x 100H

- Features:**
- Allows for height adjustment control with smart phone via application. NOTE: Only suitable for IOS devices with access to the App Store
 - For use on single and back to back workstations only
 - Minimum/Maximum height settings and up/down control
 - 10 year warranty

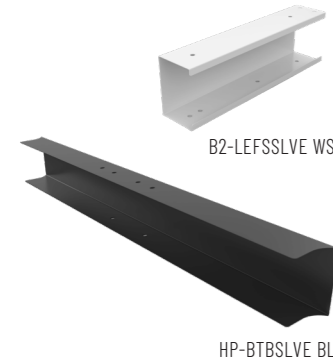

Arm & Cross Bar Sleeves

Specifications:
B2-RIGSSLVE | HP-RIGSSLVE Right Hand Side Sleeve*
B2-LEFSSLVE | HP-LEFSSLVE Left Hand Side Sleeve*
B2-BTBSLVE | HP-BTBSLVE Back to Back Cross Bar Sleeve

- Features:**
- Use to cover cable feed holes when not required or at end of workstation runs
 - Use side sleeves for Boost and Halo single sided cable tray and screen mounting arms; use back to back sleeves for cross bar of back to back workstations
 - 10 year warranty
 - *Right/Left hand side arm when sitting at desk

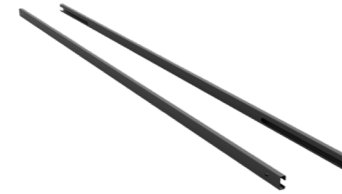

Rail Extension
B2-REX

Specifications:
Overall Size 1600W x 15D x 30H

- Features:**
- Rail extension beams
 - 2 pieces per carton
 - Suits 2100mm - 2400mmW workstations



SHS759 used on B+2PWS1275 NW/WS

Return Screen for Boost & Halo
SHS759

Specifications:
Overall Size 750W x 30D x 900H

- Features:**
- Use a 750mm return screen on one or both ends of desk
 - SHSJP900 joining pole used to join return screen to center screen
 - SHSJP1330 joining pole used as stabilising pole on the end
 - Can be used with single and back to back Boost+ and Halo+ workstations
 - Desk height can be adjusted without affecting other users or screens



Battery Pack
B2-BATT

Specifications:
Overall Size 100W x 200D x 150H

- Features:**
- For use on all Boost and Halo height adjustable workstations that don't have hard wire power access
 - Comes with control box and power charging adapter
 - Battery life up to approximately 30 up-down cycles before needing to be recharged
 - Ideal for education and training room applications



SCREENS



SHUSH30+ Tops

Specifications:

Top Options Straight desk or corner desk
 Straight Top Sizes 1200 x 750, 1500 x 750, 1800 x 750
 Corner Top Sizes 1500 x 1500, 1800 x 1200, 1800 x 1500, 1800 x 1800
 Top Finish Options Natural Oak or Natural White

Components:

Key	Code	Overall Width	Depth	Thickness
A	DST1275	1200mm	750mm	25mm
B	DST1575	1500mm	750mm	25mm
C	DST1875	1800mm	750mm	25mm
D	T1812-75	1800 x 1200mm	700mm	25mm
E	T1815-75	1800 x 1500mm	700mm	25mm
F	T1818-75	1800 x 1800mm	700mm	25mm
G	T1515-75	1500 x 1500mm	700mm	25mm
H	T1212-12-75	1205 x 1205mm	750mm	25mm
I	SCDESK BRACKET	-	-	-

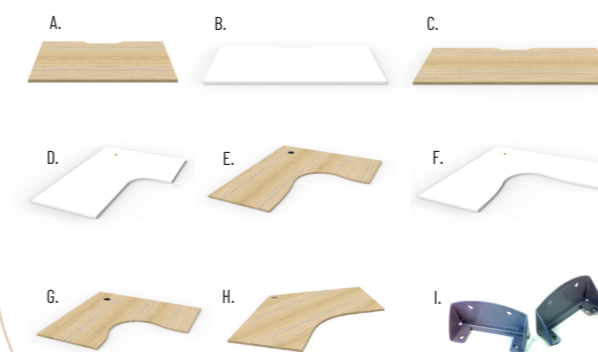

Top Finishes:



Bracket Finish:



SHUSH30+ Screens

Specifications:

Height Options 1200 or 1500
 Colour Options Black fabric/white frame or grey fabric/black frame

Components:

Key	Code	Width	Depth	Height
-	SHS712	750mm	30mm	1200mm
J	SHS1212	1200mm	30mm	1200mm
-	SHS1512	1500mm	30mm	1200mm
K	SHS1812	1800mm	30mm	1200mm
-	SHS715	750mm	30mm	1500mm
L	SHS1215	1200mm	30mm	1500mm
-	SHS1515	1500mm	30mm	1500mm
M	SHS1815	1800mm	30mm	1500mm
N	SHSJP1200	30mm	30mm	1200mm
-	SHSJP1500	30mm	30mm	1500mm
-	120D-SHSJP-1200	30mm	30mm	1200mm
O	120D-SHSJP-1500	30mm	30mm	1500mm

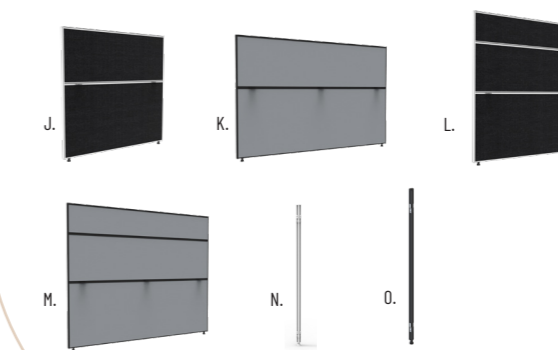

Screen Finishes:



Pole Finishes:



SHUSH30+ Legs

Features:

- Mix and match Profile, Loop, Eternity, Span or DC-60 end legs with SHUSH30+ system
- Use a range of legs instead of a screen hung system
- 5 year warranty

Components:

Key	Code	Width	Depth	Height	Colour Options
P	D-PSL	750mm	120mm	695mm	Black or White
Q	D-LSL	750mm	105mm	695mm	Black or White
R	D-ESL	750mm	233mm	695mm	Black or White
S	DC60	60mm	60mm	705mm	Black or White
T	CLEG	550mm	50mm	705mm	Silver
U	SPLEG	560mm	60mm	705mm	Black, White or Silver



Finishes:



Pictured: LRB18 - Leg block for Eternity, Loop and Profile legs. Comes in a set of 2.

SHUSH30+ Screen Hung Workstations

Features:

- Screen system with endless possible configurations
- Powdercoated frame with a full fabric pinnable screen surface
- Slimline 30mm thick screen with adjustable feet
- Comes in 2 different screen heights to choose from
- 5 year warranty

*Available in customisable Rapidline upholstery colours

Components:

Top Options	Natural Oak or Natural White with Scalloped Edge DST1275 1200W x 750D x 25H DST1575 1500W x 750D x 25H DST1875 1800W x 750D x 25H
Screen Options	Black Frame with Grey Fabric or White Frame with Black Fabric SHS712 750W x 300 x 1200H SHS1212 1200W x 300 x 1200H SHS1512 1500W x 300 x 1200H SHS1812 1800W x 300 x 1200H SHS715 750W x 300 x 1500H SHS1215 1200W x 300 x 1500H SHS1515 1500W x 300 x 1500H SHS1815 1800W x 300 x 1500H
Joining Pole	White or Black SHSJP1200 - Joining pole for 1200mm height SHSJP1500 - Joining pole for 1500mm height
Joining Brackets	Silver SCDESK BRACKET - Bracket to fasten workstation top to screen Comes as a set of 2



Top Finishes:



Screen Finishes:



SHUSH30+ Side to Side Workstations

Features:

- All of the features of the SHUSH30+ single workstation and more
- Create runs of any length to suit your space
- Configure the desks for privacy or encourage teamwork
- Mix and match screen heights and colours
- 5 year warranty



Top Finishes:



Screen Finishes:



SHUSH30+ Back to Back Workstations

Features:

- All of the features of the SHUSH30+ single workstation and more
- Maximise office space with back to back desks
- Create runs of any length to suit your space
- Configure the desks for privacy or encourage teamwork
- Mix and match screen heights and colours
- 5 year warranty



Top Finishes:



Screen Finishes:



SHUSH30+ Cubicle Workstations

Features:

- All of the features of the SHUSH30+ single workstation and more
- Use SHUSH30+ screens to build private free-standing cubicles
- Create cubicles without the need for permanent structures
- Join pods to create as many cubicles as required
- 5 year warranty

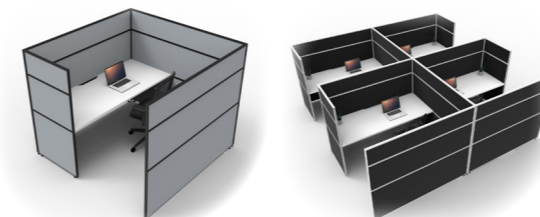
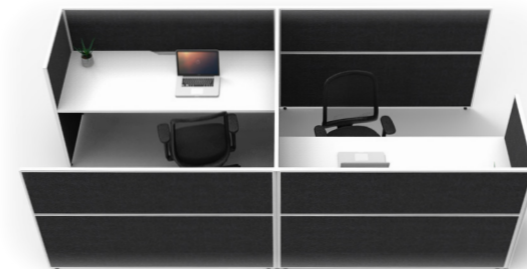

Top Finishes:



Screen Finishes:



SHUSH30+ 1-2 Person Corner Workstations

Features:

- All of the features of the SHUSH30+ single workstation and more
- Uses the same components as the SHUSH30+ single workstations
- Uses corner tops for a larger work surface
- 5 year warranty

Components:

Corner Top Size Options	Natural Oak or Natural White with Cable Entry Hole T11515-75 - 1500mm x 1500mm, 750mm Top Depth T1812-75 - 1800mm x 1200mm, 750mm Top Depth T1815-75 - 1800mm x 1500mm, 750mm Top Depth T1818-75 - 1800mm x 1800mm, 750mm Top Depth
-------------------------	---



Top Finishes:



Screen Finishes:



SHUSH30+ 4+ Person Corner Workstations

Features:

- All of the features of the SHUSH30+ corner workstation and more
- Maximise office space with back to back desks
- Create runs of any length to suit your space
- Configure the desks for privacy or encourage teamwork
- Mix and match screen heights and colours
- 5 year warranty

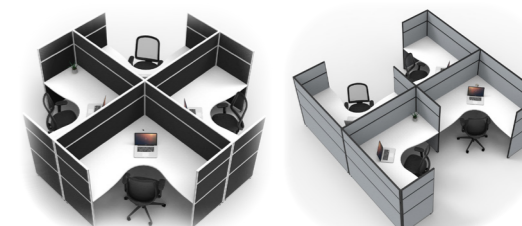

Top Finishes:



Screen Finishes:





SHUSH30+ for 120° Pods

Features:

- Use 120° pods to maximise office space
- 5 year warranty

Components:

Top Options	Natural Oak or Natural White with Cable Entry Holes T1212-12-75 - 120° workstation table top 1205W x 1205W x 750D x 25H
Screen Options	Black Frame with Grey Fabric or White Frame with Black Fabric SHS715 750W x 300 x 1500H SHS712 750W x 300 x 1200H SHS1212 1200W x 300 x 1200H SHS1215 1200W x 300 x 1500H
Leg Options	DC60 - Round Leg in Black or White SPLEG - Span Leg in Silver, Black or White C LEG - C Leg in Silver only D-PSL - Profile Leg in Black or White D-ESL - Eternity Leg in Black or White D-LSL - Loop Leg in Black or White
Joining Pole	White or Black 120D-SHSJP-1200 - Joining pole for 1200mm height 120D-SHSJP-1500 - Joining pole for 1500mm height
Joining Brackets	Silver SCDESK BRACKET - Bracket to fasten workstation top to screen. Comes as a set of 2



Top Finishes:



Screen Finishes:



SHUSH30+ Free-Standing Feet

Features:

- Used to convert SHUSH30+ screens to free-standing screens
- Attaches to side of screen extrusion for a clean finish
- Powdercoat finish
- Comes as a set of 2
- 5 year warranty

Specifications:

Product Code	Width	Depth	Height	Colour
SHSFOOT BL	505mm	66mm	125mm	Black Powdercoat
SHSFOOT WS	505mm	66mm	125mm	White Powdercoat



SHSFOOT WS



SHSFOOT BL

Finishes:



SHUSH30+ 900mm Height Screens

Features:

- SHUSH30+ 900mm height screens can be used as both screens and modesty panels when fixed using a SHS-HAB bracket
- Recommended for use with 600mm deep Infinity and Eternity legs
- Can be fixed at any height on a desk
- Functions as a screen and a modesty panel
- Brackets come as a set of 2; 1 x right, 1 x left
- 5 year warranty

Specifications:

Product Code	Product	Width	Depth	Height
SHS759	750mm wide screen	750mm	30mm	900mm
SHS129	1200mm wide screen	1200mm	30mm	900mm
SHS159	1500mm wide screen	1500mm	30mm	900mm
SHS189	1800mm wide screen	1800mm	30mm	900mm
SHS-HAB	Fixing brackets	138mm	72mm	70mm



SHS-HAB BL

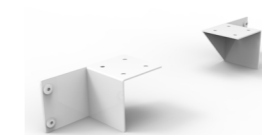

SHS-HAB WS

Bracket Finishes:



Screen Finishes:



SHUSH30+ Bracket for Height Adjustable Desks

Features:

- Use 1200mm and 1500mm full height SHUSH30+ screens, with height adjustable workstations such as BOOST+ using B2-SLIBR brackets for SHUSH30+ screen
- Holds the screen sturdy when adjusting height on workstations
- Nylon brackets come as a set of 2; 1 x right, 1 x left
- 5 year warranty

Specifications:

Product Code	Product	Width	Depth	Height
SHS1212	1200W x 1200H Screen	1200mm	30mm	1200mm
SHS1512	1500W x 1200H Screen	1500mm	30mm	1200mm
SHS1812	1800W x 1200H Screen	1800mm	30mm	1200mm
SHS1215	1200W x 1500H Screen	1200mm	30mm	1500mm
SHS1515	1500W x 1500H Screen	1500mm	30mm	1500mm
SHS1815	1800W x 1500H Screen	1800mm	30mm	1500mm
SHS712	750W x 1200H Screen	750mm	30mm	1200mm
SHS715	750W x 1500H Screen	750mm	30mm	1500mm
SHSJP1200	Joining Pole for 1200H Screen	30mm	30mm	1200mm
SHSJP1500	Joining Pole for 1500H Screen	30mm	30mm	1500mm
B2-SLIBR	Nylon glide brackets	25mm	8mm	50mm



B2-SLIBR

Bracket Finish:



Joining Pole Finishes:



Screen Finishes:







ECO Panel Screens

- Features:**
- Sound absorbing screens come in black or marble grey
 - Polyester fibre panel screen with pinnable surface & radial corners
 - Moisture resistant and anti-mildew
 - 3 year warranty
- *Screen mounting clamps sold separately

Screen options:

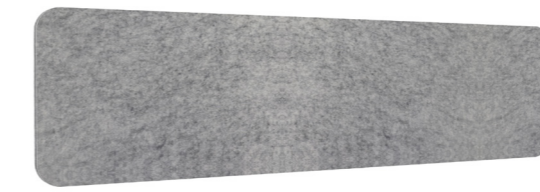
Product Code	Width	Depth	Height	Finished Height (with clamps)
EPS750	740mm	27mm	384mm	400mm
EPS1200	1200mm	27mm	384mm	400mm
EPS1500	1500mm	27mm	384mm	400mm
EPS1800	1800mm	27mm	384mm	400mm
EPS129	1200mm	27mm	900mm	916mm
EPS159	1500mm	27mm	900mm	916mm
EPS189	1800mm	27mm	900mm	916mm



Screen Finishes: 

ECO Panel Clamps

- Features:**
- Powdercoated clamps come in a set of 2
 - Available in a choice of black or white powdercoat
 - Clamps used for mounting screens with a thickness of 12mm - 31mm
 - Desk mounted clamps screw in from top of desk
 - Side and back to back versions screw in from bottom of desk
 - 5 year warranty

Clamp options:

Product Code	Width	Depth	Height	Use for
EPSCCLAMP	42mm	65mm	82mm	Desk mounted clamp
EPSCMC	44mm	35mm	95mm	Side mounted clamp
BTBEPSC	70mm	44mm	100mm	Back to back clamp



Clamp Finishes: 

ECO Slide on Screen

- Features:**
- Polyester fibre panel pinnable surface
 - Suits 25mm thick tops and requires no fixings
 - Moisture resistant and anti-mildew
 - 3 year warranty

Specifications:

Product Code	SEPS70
Overall Width	820mm
Overall Height	530mm
Screen Thickness	27mm
Height from Cavity to Top of Screen	400mm
Length from Cavity to End of Screen	700mm
Cavity Height	24mm
Corner Radius	40 Degrees



Screen Finishes: 

SOFTWIRING & CABLE MANAGEMENT



Pop Up Power

Specifications:

SWPOP2G	2 x GPO
SWPOP1G2USB	1 x GPO + 2 x USB

Features:

- Pop up power module - offers above desk power, data and USB
- Can be concealed when not in use
- Leads not included
- Available in black or white
- 2 year warranty

Finishes:



Nova Trio Power Rail

Specifications:

SWNOVA2GUSBA/C	2 x GPO + 1 x USB C + 1 x USB A
----------------	---------------------------------

Features:

- 2 x 10AMP Auto Switched Socket Outlet, 1 x USB C Outlet, 1 x USB A Outlet
- 1500mm lead with 3 pin plug included
- Available in black or white
- 2 year warranty

Finishes:



Athena Power Rail

Specifications:

SWPR2G	2 x Rotated GPO
SWPR2G2USB	2 x GPO + 2 x USB A
SWPR2G2D	2 x GPO + 2 Data Provision
SWPR4G3D	4 x GPO + 3 x Data Provision
SWPR2GUSBA/C	2 x GPO + 1 x USB A + 1 x USB C

Features:

- Includes tag lead D, splitter & desk clamps for attaching to desk
- 2 year warranty

Finishes:



Boardroom Table Box

Specifications:

SWTB2G3D	2 x GPO + 3 Data Provision
SWTB4G5D	4 x GPO + 5 x Data Provision

Features:

- Sits in desk or table top
- Lid closes to hide points when not in use
- Leads not included
- Available in black, silver or white
- 2 year warranty

Finishes:





Odyssey Power Dock

Specifications:

ODYS2G2USBTPP	2 x GPO, 1 x USB A, 1 x USB C, 1500mm 3-pin lead
ODYS4G4USBTPP	4 x GPO, 2 x USB A, 2 x USB C, 1500mm 3-pin lead
ODYS8G4USBTPP	8 x GPO, 2 x USB A, 2 x USB C, 1500mm 3-pin lead

Features:

- Power solution for where shared power is required
- Use in boardrooms, conference areas, hot desking
- 2 year warranty

Finishes:



Power Poles

Specifications:

Desk to Ceiling Kit Includes	2.1m power pole or umbilical kit for desk to ceiling power with ceiling kit, under desk mounting bracket, desk grommet and cover
Floor to Ceiling Kit Includes	2.8m power pole or umbilical kit for floor to ceiling power with ceiling kit, floor bracket and cover

Features:

- Perfect in open plan offices with desks in the centre of the room
- Carries cables and wiring to desk from the ceiling
- 2 year warranty

Finishes:



Single Cable Basket

Specifications:

Available Widths	SWBK650 - 650mm for 900mm wide desks SWBK950 - 950mm for 1200mm wide desks SWBK1250 - 1250mm for 1500mm wide desks SWBK1550 - 1550mm for 1800mm wide desks
Available Options	• 2 x GPO • 4 x GPO • 6 x GPO

Features:

- Includes basket, power module, GPO clip, and interconnecting lead
- Under desk cable basket kit to organise power cables
- 2 year warranty

Finishes:



Atom USB Charging

Specifications:

ATOMUSB	2 x USB + 1500mm 3-pin lead
ATMBRACK	Under desk & lounge mounting bracket

Features:

- USB charging module
- Can be integrated into desk top or fixed underneath desk top, or mounted to lounges using the mounting bracket
- Available in black or white
- 2 year warranty

Finishes:



Blinky Power Pod

Specifications:

BLKY3GTL	3 x GPO + 500mm TAG lead
BLKY3GTPP	3 x GPO + 1500mm 3-pin lead
BLKY3G3USBTLL	3 x GPO + 3 x USB C + 500mm TAG lead
BLKY3G3USBPP	3 x GPO + 3 x USB C + 1500mm 3-pin lead

Features:

- Multi-power pod with different power configurations available
- Sits on desk top - fits in 135mm diameter cutout
- 2 year warranty

Finishes:

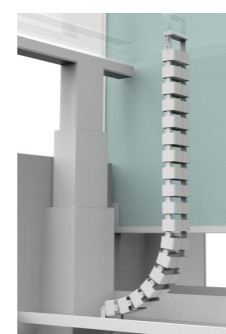

Trax Umbilical

Specifications:

SWTD12	1200mm length umbilical for use with height adjustable workstations
--------	---

Features:

- Solution for height adjustable desks
- Cable tray to workstation umbilical
- Dual compartment for power and data
- SWTDMAG - magnet for fixing to steel bases available for additional cost
- Includes tray base fixing, and under desk bracket
- 2 year warranty

Finishes:



Dual Cable Basket

Specifications:

Available Widths	SWBK650 - 650mm for 900mm desks SWBK950 - 950mm for 1200mm desks SWBK1250 - 1250mm for 1500mm desks SWBK1550 - 1550mm for 1800mm desks
Available Options	• 2 x GPO with 2 data tiles • 4 x GPO with 2, 3 or 4 data tiles • 6 x GPO with 2, 3 or 4 data tiles

Features:

- Under desk cable basket kit to organise power and data cables
- Includes basket, power module, GPO clip, interconnecting lead & data tile
- 2 year warranty

Finishes:



Konexus Module

Specifications:

SWKNGPTL	1 x GPO + 1000mm Lead With Tag Connector
SWKNGP3P	1 x GPO + 1500mm 3 Pin Lead (10A)
SWKNGPUSB65TL	1 x GPO + USB A/C Fast Charge Outlets (65W Shared) + 1000mm Lead With Tag Connector
SWKNGPUSB653P	1 x GPO + USB A/C Fast Charge Outlets (65W Shared) + 1500mm 3 Pin Lead (10A)

Features:

- In desk module, available in black or white
- 2 year warranty

Finishes:



NEW



Elevate Single Arm
ELEVATE ARM

Specifications:
Tilt Range 180°
Weight Limit Min. 2kg - Max 8kg
Screen Limit Up to 24"
Forward Range 500mm
Vertical Range 180-480mm

Features:

- Single swivel monitor arm with 180-480mm height range
- 180° adjustment and clamp fix kit
- 3 year warranty

Finishes:



Linea Single Arm
LINSMA1 WH | LINSMA1 BK

Specifications:
Tilt Range -90° to 15°
Rotate 360°
Weight Limit 2-9kg
Suits screens 17-35"
VESA size 75 x 75mm & 100 x 100mm

Features:

- Mechanical spring
- Manual & visual adjustment
- Clamp & grommet hole fixings included, quick installation
- 10 year warranty

Finishes:



Forge Single Arm
FOSMA1 WH | FOSMA1 BK

Specifications:
Tilt Range -90° to 15°
Rotate 360°
Weight Limit 2-20kg
Suits screens 17-49"
VESA size 75 x 75mm & 100 x 100mm

Features:

- Heavy duty, holds larger screens
- Features a quick release VESA plate
- Clamp & grommet hole fixings included, quick installation
- 10 year warranty

Finishes:



Core Single Arm
CSMA1 BK

Specifications:
Tilt Range Approx. 90° to 15°
Weight Limit 2-9kg
Suits screens 17-30"
VESA size 75 x 75mm & 100 x 100mm

Features:

- Clamp & grommet hole fixings included
- Gas spring
- Quick release
- 10 year warranty

Finish:



Core Dual Arm
CDMA2 BK

Specifications:
Tilt Range -90° to 15°
Weight Limit 2-9kg per arm
Suits screens 17-30" per arm
VESA size 75 x 75mm & 100 x 100mm

Features:

- Clamp & grommet hole fixings included
- Gas spring
- Quick release
- 10 year warranty

Finish:



Horizon TV Mount
HRZTVM BK

Specifications:
Tilt Range Approx. 0° to 12°
Weight Limit 70kg
Suits screens 42-90"
VESA size 600mm x 400mm
Wall distance 48mm

Features:

- 10 year warranty

Finish:



Reach TV Mount
REATVM BK

Specifications:
Tilt Range -5° to 10°
Swivel Range Approx. +45° to -45°
Screen Level Approx. +3° to -3°
Weight Limit 70kg
Suits screens 47-90"
VESA size 800mm x 600mm
Wall distance 77mm to 609mm

Features:

- 10 year warranty

Finish:

NEW

NEW

NEW

NEW

NEW

NEW

TABLES



Drum Base Table DBT900 | DBT1200

Features:

- Includes 20mm self-taping wood screws for table top fixing
- Adjustable leveling feet
- 25mmT E0 rated melamine top
- Drum base finished in chip resistant powdercoat
- 5 year warranty

Specifications:

Product Code	Top Diameter	Base Diameter	Height
DBT900	900mm	450mm	730mm
DBT1200	1200mm	600mm	730mm

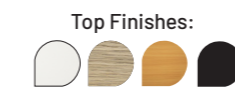

NEW SIZES

Estilo Disc Base Table CBT5 | CBT6 | CBT9 | CBT12 | CBT990

Features:

- Flush flat disc base plate
- Adjustable Leveling Feet
- E0 Enviroboard tops
- Suitable For Indoor Use
- Bases available in Stainless steel, Black powdercoat or White powdercoat
- Not all sizes available in all colours. See below
- 5 year warranty

Specifications:

Product Code	Size	Height	Top colours
CBT5	500 Diameter	755mm	*White, Oak or Black tops only
CBT6	600 Diameter	755mm	White, Oak, Black or Beech
CBT9	900 Diameter	755mm	White, Oak, Black or Beech
CBT12	1200 Diameter	755mm	White, Oak, Black or Beech
CBT990	900 x 900mm	755mm	*White or Oak tops only

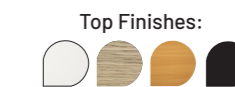



Eternity Table Round

D-ERT9 | D-ERT12

Specifications:
 D-ERT9 900 Diameter x 730H
 D-ERT12 1200 Diameter x 730H

- Features:**
- 45° profile leg
 - Powdercoat base with adjustable feet
 - E0 melamine board table top
 - 5 year warranty

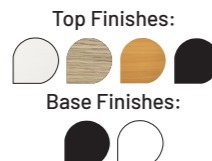

Eternity Table Square

D-ERT990

Specifications:
 D-ERT990 900W x 900D x 730H

- Features:**
- 45° profile leg
 - Powdercoat base with adjustable feet
 - E0 melamine board table top in Natural White or Natural Oak
 - 5 year warranty



Worker Round Table

CRM9 | CRM12

Specifications:
 CRM9 900 Diameter x 730H
 CRM12 1200 Diameter x 730H

- Features:**
- Full E0 melamine board top and base
 - Solid melamine Ironstone base
 - Beech coloured top
 - Available in 2 sizes
 - Matches with Rapid Worker range
 - 5 year warranty

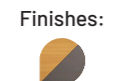

Profile Frame Table

DIT126 | DIT1575 | DIT1875 | DIT2175

Specifications:
 DIT126 1200W x 600D x 730H
 DIT1575 1500W x 750D x 730H
 DIT1875 1800W x 750D x 730H
 DIT2175 2100W x 750D x 730H

- Features:**
- 60mm x 30mm profile leg underframe in black or white powdercoat
 - Dual cross bar for added stability, adjustable leveling feet
 - AFRDI certified
 - 5 year warranty



NEW



Typhoon 4 Star Table

TTR | BTTR

Specifications:
 TTR900 | BTTR900 900 Diameter x 750H
 TTR1200 | BTTR1200 1200 Diameter x 750H

- Features:**
- 4 star base with adjustable feet
 - Frames available in polished aluminium/black or black powdercoat all over
 - E0 melamine board table top
 - 5 year warranty

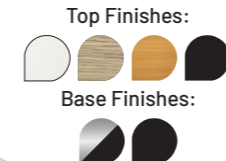

Typhoon Meeting

TTR | BTTR

Specifications:
 TTR189 | BTTR189 1800W x 900D x 750H
 TTR1575 | BTTR1575 1500W x 750D x 750H
 TTR1875 | BTTR1875 1800W x 750D x 750H

- Features:**
- E0 melamine top in Natural White, Natural Oak, or Beech
 - Frames in black powdercoat and polished aluminium/black
 - Adjustable leveling feet
 - 5 year warranty

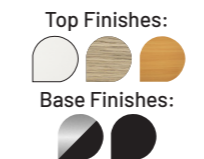

Typhoon Round Table

TTR1500 | BTTR1500

Specifications:
 Overall Size 1500 Diameter x 750H

- Features:**
- E0 melamine top in Natural White or Natural Oak
 - 4 star base with adjustable feet
 - Base available in polished aluminium/black or black powdercoat
 - 5 year warranty

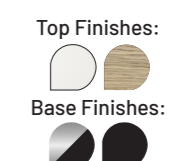

Typhoon Boardroom

TTR | BTTR

Specifications:
 TTR2412 | BTTR2412 2400W x 1200D x 750H
 TTR3212 | BTTR3212 3200W x 1200D x 750H
 TTR4012 | BTTR4012 4000W x 1200D x 750H

- Features:**
- E0 melamine top, with frames available in black powdercoat and polished aluminium/black
 - 4000mm tables only available in Natural Oak and Natural White
 - 1 piece top for 2400W size, 2 piece top for 3200W & 4000W size
 - 5 year warranty





Drum Base D-End Table

DB-DEND1810 | DB-HBDE1810

NEW

Features:

- 25mm Thick E0 melamine
- Wall fixing plinth included with tabletop
- Drum base finished in black or white powdercoat
- D-End tabletop finished in black, natural oak or white with matching edge tape
- Available in 2 heights
- Meeting table underframe: 450mm Dia x 705mm H
- High table underframe: 450mm Dia x 1025mm H
- Adjustable Leveling Feet
- 5 year warranty

Specifications:

Product Code	Width	Depth	Height
DB-DEND1810	1800mm	1000mm	730mm
DB-HBDE1810	1800mm	1000mm	1050mm



Top Finishes:

Base Finishes:

Estilo Disc Base D-End Table

CBDET1810

NEW

Features:

- 25mm Thick E0 melamine
- Disc base underframe finished in stainless steel, black or white powdercoat
- D-End tabletop finished in black, natural oak or white with matching edge tape
- Wall fixing plinth included with tabletop
- 5 year warranty

Specifications:

Product Code	Width	Depth	Height
CBDET1810	1800mm	1000mm	745mm



Top Finishes:

Base Finishes:



Eternity Meeting
EMT1575 | EMT1875 | EMT189

Specifications:
EMT1575 1500W x 750D x 730H
EMT1875 1800W x 750D x 730H
EMT189 1800W x 900D x 730H

- Features:**
- E0 melamine top in Natural White, Natural Oak, or Beech
 - Powdercoat base with adjustable feet in black or white
 - Double support rails under single piece top
 - 5 year warranty



Eternity Boardroom
EMT2175 | EMT2412 | EMT3212

Specifications:
EMT2175 2100W x 750D x 730H
EMT2412 2400W x 1200D x 730H
EMT3212 3200W x 1200D x 730H - with intermediate leg
EMT4012 4000W x 1200D x 730H - with intermediate leg

- Features:**
- E0 rated, 25mm thick melamine top
 - Double support rails under 2-piece tops
 - EMT2175 & EMT4012 not available in Beech top
 - 5 year warranty



Steel Frame Table
SFT126 | SFT1575 | SFT1875 | SFT189

Specifications:
SFT126 1200W x 600D x 730H
SFT1575 1500W x 750D x 730H
SFT1875 1800W x 750D x 730H
SFT189 1800W x 900D x 730H

- Features:**
- Black steel frame with adjustable leveling feet
 - E0 melamine board table top
 - 3 year warranty



Ironstone Boardroom
CBT2412 | CBT3212

Specifications:
CBT2412 2400W x 1200D x 730H
CBT3212 3200W x 1200D x 730H

- Features:**
- Made entirely of E0 Melamine board
 - Sturdy H shape base in Ironstone finish
 - E0 melamine top in Natural White, Natural Oak, or Beech
 - 1 piece top for 2400mm size, 2 piece top for 3200mm size
 - 5 year warranty

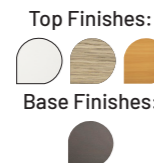

Span Meeting Table
RST1875 | RST189

Specifications:
RST1875 1800W x 750D x 730H
RST189 1800W x 900D x 730H

- Features:**
- Stylish angled frame
 - Adjustable feet
 - E0 melamine top in Natural White, Natural Oak, or Beech
 - 5 year warranty

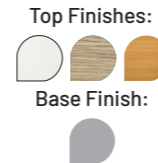

Typhoon Flip Top
TFT | BTFT

Specifications:
TFT126 | BTFT126 1200W x 600D x 750H
TFT1575 | BTFT1575 1500W x 750D x 750H
TFT1875 | BTFT1875 1800W x 750D x 750H
TFT2175 | BTFT2175 2100W x 750D x 750H

- Features:**
- Easy storage when not in use, includes locking castors
 - Frames in black powdercoat or polished aluminium/black
 - 2100mm tables only available in Natural Oak and Natural White
 - Table links available for additional cost
 - 5 year warranty

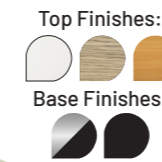

Boost Crank Flip Top
BCFTT1575 | BCFTT1875 | BCFTT189

Specifications:
BCFTT1575 1500W x 750D x 725-1070H
BCFTT1875 1800W x 750D x 725-1070H
BCFTT189 1800W x 900D x 725-1070H

- Features:**
- Side winder crank handle
 - Heavy-duty castors - 2x locking castors & 2x non-locking castors
 - Max speed: 15mm per second (10mm per full turn circle)
 - Foot size of 650mm
 - 5 year warranty



Flip Top Table
FTT1575 | FTT1875

Specifications:
FTT1575 1500W x 750D x 750H
FTT1875 1800W x 750D x 750H

- Features:**
- Padded pull handle and locking castors
 - Table links available for additional cost
 - E0 melamine board table top
 - 3 year warranty

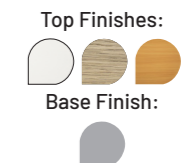



Steel Folding Table
FFT1575 | FFT1875 | FFT189

Specifications:
 FFT1575 1500W x 750D x 730H
 FFT1875 1800W x 750D x 730H
 FFT189 1800W x 900D x 730H

- Features:**
- Suitable for heavy-duty use
 - Easy to use folding mechanism and easy storage
 - E0 melamine board table top
 - 3 year warranty



Disc Base Bar Table
CDBT6 | CDBT9

NEW SIZE

Specifications:
 CDBT6 600 Diameter x 1050H
 CDBT9 900 Diameter x 1050H

- Features:**
- Flush flat disc base
 - E0 melamine top
 - Top available in Natural White, Natural Oak, Beech, or Black
 - Base available in black, white, stainless steel
 - 5 year warranty



Eternity High Bar
D-EHBT

Specifications:
 D-EHBT1575 1500W x 750D x 1050H
 D-EHBT1875 1800W x 750D x 1050H
 D-EHBT189 1800W x 900D x 1050H
 D-EHBT2175 2100W x 750D x 1050H

- Features:**
- Stylish splayed leg available in black or white powdercoat
 - E0 melamine top in Natural White, or Natural Oak
 - Dual cross bar for added stability
 - 3 year warranty

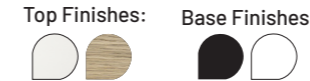

Eternity Long High Bar
D-EHBT

Specifications:
 D-EHBT3075 3000W x 750D x 1050H
 D-EHBT3675 3600W x 750D x 1050H
 D-EHBT3690 3600W x 900D x 1050H
 D-EHBT4275 4200W x 750D x 1050H

- Features:**
- E0 melamine top in Natural White or Natural Oak
 - Stylish splayed leg available in black or white powdercoat
 - 2 piece table top with intermediate leg and dual cross bar for stability
 - 5 year warranty



Rapid Edge Folding
FBT2410

Specifications:
 FBT2410 2400W x 1000D x 743H

- Features:**
- Folding table, top folds in half
 - Natural White or Driftwood top with black rubber strip edging
 - Quick release mechanism
 - Includes 2 x table links
 - Frame in polished aluminium/black
 - 5 year warranty

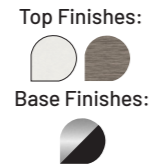

Drum Base High Table
DB-HBT600 | DB-HBT900

Specifications:
 DB-HBT600 600 Diameter x 1050H
 DB-HBT900 900 Diameter x 1050H

- Features:**
- Includes 20mm self tapping wood screws for table top fixing
 - Adjustable leveling feet
 - 25mmT E0 rated melamine top
 - Drum base finished in chip resistant powdercoat
 - 5 year warranty



Drafting Height Table
9SFT1575 | 9SFT189

Specifications:
 9SFT1575 1500W x 750D x 900H
 9SFT189 1800W x 900D x 900H

- Features:**
- Drafting height table
 - Black powdercoat steel frame
 - E0 melamine top in Natural White, Natural Oak, or Beech
 - 3 year warranty

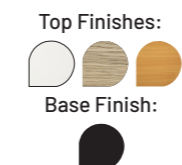

High Bar Table
HBT189

Specifications:
 Overall Size 1800W x 900D x 1050H

- Features:**
- Powdercoat frame in black
 - Cross bar foot rest
 - E0 melamine top in Natural White, Natural Oak, or Beech
 - 3 year warranty

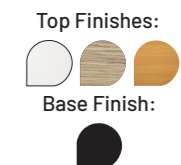

SEATING



Titan High Back TITAN HB BL | TITAN HB CR

NEW

Specifications:

Overall Size	720W x 670D x 1100 - 1190H
Seat Size	460W x 420D x 445 - 535H
Weight Rating	135kg

Features:

- Heavy duty executive chair in Black or Coral finishes
- Heavy duty synchronised mechanism 28° tilt, 5 locking positions
- Height adjustable, 4D adjustable arm rests, seat slide
- Head rest with 10 different locking heights
- Adjustable lumbar support
- 10 year warranty

Finishes:



Zephyr Chair ZEPHYR BL | ZEPHYR BPU

NEW

Specifications:

Overall Size	655W x 640D x 990 - 1110H
Seat Size	510W x 490D x 460 - 580H
Weight Rating	120kg

Features:

- Mesh back operator chair
- Available in black fabric or PU seat pad
- Arms not included, compatible with Breeze arms
- 5 year warranty

Finishes:



Breeze Chair BREEZE BL | BREEZE ARMS

Specifications:

Overall Size	650W x 650D x 995-1095H
Seat Size	530W x 500D
Seat Height	480-580H
Weight Rating	135kg

Features:

- Height adjustable lumbar support, manual back rest tensioner
- Black nylon 5 star base, black mesh back, black fabric seat
- 4 lever ergonomic mechanism with seat slide
- 10 year warranty
- Arms not included

*Adjustable arms and Rapidline upholstery available for extra

Finishes:



Gust Chair GUST HD FBK

Specifications:

Overall Size	690W x 630D x 1100-1260H
Seat Size	540W x 500D
Seat Height	455-555H
Weight Rating	160kg

Features:

- Height adjustable lumbar support
- Heavy-duty 4 lever ergonomic mechanism with seat slide
- Black fabric seat pan with black mesh back
- 10 year warranty
- Arms not included, compatible with Breeze arms

*Adjustable arms and Rapidline upholstery available for extra

Finishes:





Luminous Chair
LUMINOUS TASK

Specifications:

Overall Size 625W x 500D x 960-1030H
 Seat Size 480W x 545D
 Seat Height 420-510H
 Weight Rating 135kg

Features:

- Black mesh, high back executive chair
- Height adjustable with synchro mechanism and adjustable arms
- Black fabric seat with off-white frame
- 10 year warranty

*Head rest and customisable Rapidline upholstery available

Finishes:



Arco Chair
ARCO BL

Specifications:

Overall Size 720W x 580D x 1020-1110H
 Seat Size 510W x 500D
 Seat Height 450-540H
 Weight Rating 135kg

Features:

- F020S synchronised mechanism with 4 locking positions
- Seat slide, height adjustment, 3D adjustable arms
- Nylon base on castors
- Black fabric seat with black mesh back
- 10 year warranty

Finish:



Oasis Chair
OASIS BL

Specifications:

Overall Size 650W x 620D x 960-1035H
 Seat Size 490W x 515D
 Seat Height 490-565H
 Weight Rating 135kg

Features:

- Height adjustable full mesh chair
- Nylon base on castors, nylon armrests and Donati mechanism
- Black mesh back and mesh seat for ultimate breathability
- 10 year warranty

Finish:



Orca Chair
ORCA BL

Specifications:

Overall Size 730W x 655D x 1030-1120H
 Seat Size 520W x 575D
 Seat Height 460-550H
 Weight Rating 135kg

Features:

- 5-star chrome base on castors
- F020S synchronised mechanism with 4 locking positions
- Seat slider & 3D adjustable arms
- 80mm thick moulded foam seat, black seat and mesh back
- 10 year warranty

Finish:



Kal Chair
KAL TASK

Specifications:

Overall Size 640W x 605D x 965-1055H
 Seat Size 500W x 510D
 Seat Height 430-520H
 Weight Rating 135kg

Features:

- Height adjustable, lumbar support, synchro mechanism
- Tension control and adjustable arms
- Black fabric seat with black mesh back and black frame
- 10 year warranty

*Head rest and customisable Rapidline upholstery available

Finishes:



Cascade Mesh Chair
CASCADE MB BK

Specifications:

Overall Size 625W x 625D x 1015-1115H
 Seat Size 510W x 520D
 Seat Height 500-600H
 Weight Rating 110kg

Features:

- Back rest and seat pan tilt
- Black fabric seat with black mesh back rest
- Adjustable lumbar support
- Removable adjustable arms
- 5 year warranty

Finishes:



Lotto Medium Back
LOTTO MB

Specifications:

Overall Size 685W x 580-660D x 950-1040H
 Seat Size 500W x 480D
 Seat Height 430-530H
 Weight Rating 135kg

Features:

- Height adjustable, lumbar support, synchro mechanism
- Gas lift, back rest and seat pan tilt
- Fabric seat with mesh back and removable adjustable arms
- Black or white 5 star base on castors
- 5 year warranty

*Head rest and customisable Rapidline upholstery available

Finishes:



Ergo Task Chair
ERGO TASK | ERGO ARMS

Specifications:

Overall Size 520W x 540D x 950-1040H
 Seat Size 520W x 490D
 Seat Height 450-540H
 Weight Rating 165kg

Features:

- Fully ergonomic black fabric seat and mesh back chair
- Height adjustable with seat slide and ratchet back
- Suitable for heavy-duty use
- 10 year warranty

*Adjustable arms and Rapidline upholstery available for extra

Finishes:





SGS

Vesta Chair
VESTA BL

Specifications:

Overall Size	630W x 630D x 870-970H
Seat Size	460W x 460D
Seat Height	430-530H
Weight Rating	90kg

Features:

- Black mesh back chair with black fabric seat
- Height adjustable chair with single point lock
- Fixed arms
- 1 year warranty

Finish:



EM300 Chair
EM300 BL | EM300 PU

Specifications:

Overall Size	490W x 520D x 920-1050H
Seat Size	490W x 440D
Seat Height	460-590H
Weight Rating	110kg

Features:

- Fully ergonomic, height adjustable mesh back chair
- Injection moulded foam seat in Black fabric of Black PU
- Arms, chrome base and drafting kit compatibility
- 5 year warranty
- *Customisable Rapidline seat upholstery available

Finishes:



Hartley Task
HARTLEY TASK

Specifications:

Overall Size	630W x 500D x 950-1015H
Seat Size	500W x 480D
Seat Height	440-520H
Weight Rating	135kg

Features:

- Synchro mechanism with tension control
- Moulded foam seat, black mesh back
- Adjustable arms, adjustable height
- 10 year warranty
- *Head rest and customisable Rapidline upholstery available

Finishes:



CL610 Chair
CL610

Specifications:

Overall Size	620W x 680D x 1010-1140H
Seat Size	495W x 500D
Seat Height	450-580H
Weight Rating	120kg

Features:

- Medium back executive chair with black base and castors
- Soft black PU upholstery
- 4 point tilt lock, height adjustable
- Fixed curved armrests
- 5 year warranty

Finish:



SGS

Vienna Chair
VIENNA

Specifications:

Overall Size	610W x 610D x 980-1100H
Seat Size	490W x 490D
Seat Height	430-550H
Weight Rating	100kg

Features:

- Mesh back available in black, or silver
- Height adjustable chair on a 5 star base with castors
- Tilt lock mechanism, fixed loop arms and black fabric seat
- 3 year warranty

Finishes:



AM100 Chair
AM100 BK

Specifications:

Overall Size	650W x 610D x 990-1080H
Seat Size	470W x 490D
Seat Height	460-550H
Weight Rating	120kg

Features:

- Height adjustable chair with seat and back tilt
- Curved black mesh back, black fabric seat
- Adjustable arms
- Fully ergonomic
- 5 year warranty

Finish:



Hartley Visitor
HARTLEY VISITOR

Specifications:

Overall Size	640W x 480D x 950H
Seat Size	510W x 480D x 440H
Weight Rating	135kg

Features:

- Black cantilever frame chair with adjustable arms as standard
- Black mesh back with black fabric seat
- Comfortable padded fabric seat
- 10 year warranty
- *Customisable Rapidline upholstered seat available

Finishes:



SGS

CL410 Chair
CL410

Specifications:

Overall Size	650W x 720D x 1190-1290H
Seat Size	540W x 500D
Seat Height	450-550H
Weight Rating	120kg

Features:

- Soft black PU upholstery with fabric inlay
- Infinite tilt lock, height adjustable
- Fixed curved arm rests
- Chrome base
- 5 year warranty

Finish:





CL820 Chair
CL820

Specifications:
Overall Size 670W x 740D x 1180-1250H
Seat Size 520W x 480D
Seat Height 420-490H
Weight Rating 130kg

- Features:**
- Soft black PU upholstery
 - Infinite tilt lock, height adjustable
 - Fixed curved polished aluminium arms
 - Chrome base
 - 5 year warranty



PU900 Medium Back
PU900M

Specifications:
Overall Size 580W x 530D x 890-960H
Seat Size 520W x 435D
Seat Height 460-545H
Weight Rating 120kg

- Features:**
- Medium back upholstered in black PU
 - Single point lock, height adjustable
 - Polished aluminium base and fixed arms
 - 5 year warranty



Accord High
ACCORD HB GBL

Specifications:
Overall Size 680W x 730D x 1210-1310H
Seat Size 420W x 500D
Seat Height 420-520H
Weight Rating 110kg

- Features:**
- Accord genuine leather high back executive chair
 - Easy adjust tilt tension control with heavy-duty tilt mechanism
 - Polished aluminium 5 star base on castors
 - 10 year warranty



Accord Medium
ACCORD MB GBL

Specifications:
Overall Size 650W x 720D x 1010-1100H
Seat Size 420W x 500D
Seat Height 400-500H
Weight Rating 110kg

- Features:**
- Accord genuine leather medium back executive chair
 - Easy adjust tilt tension control with heavy-duty tilt mechanism
 - Polished aluminium 5 star base on castors
 - 10 year warranty



PU605 Medium Back
PU605M

Specifications:
Overall Size 650W x 510D x 980-1030H
Seat Size 485W x 460D
Seat Height 490-540H
Weight Rating 120kg

- Features:**
- Medium back executive chair in black or tan PU
 - Infinite lock, height adjustable
 - Polished aluminium or black powdercoat base
 - 5 year warranty



PU900 High Back
PU900H

Specifications:
Overall Size 585W x 530D x 1050-1135H
Seat Size 500W x 415D
Seat Height 460-550H
Weight Rating 120kg

- Features:**
- High back upholstered in black PU
 - Single point lock, height adjustable
 - Polished aluminium base and fixed arms
 - 5 year warranty



Mirage High Back
MIRAGE HB

Specifications:
Overall Size 700W x 700D x 1140-1200H
Seat Size 535W x 490D
Seat Height 440-500H
Weight Rating 120kg

- Features:**
- Upholstered in soft, genuine Tan or Black leather
 - 700mm Diameter polished aluminium 5 star base on castors
 - Easy adjust tilt tension control with heavy-duty tilt mechanism
 - Fixed height arm rest finished in hard wearing black vinyl
 - 10 year warranty



Mirage Medium Back
MIRAGE MB

Specifications:
Overall Size 700W x 700D x 960-1020H
Seat Size 520W x 490D
Seat Height 440-500H
Weight Rating 120kg

- Features:**
- Upholstered in soft, genuine tan or black leather
 - 700mm Diameter polished aluminium 5 star base on castors
 - Easy adjust tilt tension control with heavy-duty tilt mechanism
 - Fixed height arm rest finished in hard wearing black vinyl
 - 10 year warranty





PU300 Chair
PU300

Specifications:
Overall Size 670W x 640D x 1090-1170H
Seat Size 540W x 450D
Seat Height 510-590H
Weight Rating 130kg

- Features:**
- Fully ergonomic soft black PU chair
 - Ratchet back, seat slide, height adjustable
 - Chrome base with castors
 - Adjustable arms in black
 - 10 year warranty

Finish:



EC070CM Chair
EC070CM

Specifications:
Overall Size 480W x 580D x 900-1030H
Seat Size 500W x 450D
Seat Height 470-600H
Weight Rating 120kg

- Features:**
- AFRDI level 6 certified chair
 - Injection moulded foam seat
 - Fully ergonomic medium back, black fabric chair
 - Seat and back tilt with gas lift
 - 3 year warranty
- *Customisable Rapidline seat upholstery available

Finishes:



EC070BM Chair
EC070BM

Specifications:
Overall Size 500W x 450D x 900-1030H
Seat Size 500W x 450D
Seat Height 470-600H
Weight Rating 120kg

- Features:**
- AFRDI level 6 certified chair
 - Medium back, back tilt and gas lift
 - Injection moulded foam seat with black fabric upholstery
 - 3 year warranty
- *Customisable Rapidline upholstery available

Finishes:



ET20 Chair
ET20 BK

Specifications:
Overall Size 480W x 460D x 830-940H
Seat Size 480W x 460D
Seat Height 420-530H
Weight Rating 100kg

- Features:**
- Black fabric medium back chair with black base and castors
 - Injection moulded foam, upholstery for additional costs
 - Gas lift, back and seat tilt
 - 3 year warranty
- *Customisable Rapidline seat upholstery available

Finishes:



EG 100 Chair
EG100CH BL

Specifications:
Overall Size 520W x 510D x 1010-1150H
Seat Size 520W x 480D
Seat Height 480-620H
Weight Rating 130kg

- Features:**
- AFRDI level 6 chair on black base with castors
 - Injection moulded foam seat
 - Fully ergonomic high back, black fabric seat
 - Seat and back tilt with gas lift
 - 10 year warranty
- *Customisable Rapidline seat upholstery available

Finishes:



EC070CH Chair
EC070CH

Specifications:
Overall Size 500W x 450D x 990-1120H
Seat Size 500W x 450D
Seat Height 470-600H
Weight Rating 120kg

- Features:**
- Fully ergonomic high back black fabric chair
 - Injection moulded foam seat
 - Seat and back tilt with gas lift
 - 3 year warranty
- *Customisable Rapidline seat upholstery available

Finishes:



EC070BM Drafting
EC070BM DRAFTING

Specifications:
Overall Size 500W x 450D x 1060-1230H
Seat Size 500W x 450D
Seat Height 630-800H
Weight Rating 120kg

- Features:**
- Medium back drafting chair with black fabric seat
 - Back tilt, gas lift, injection moulded foam seat
 - Adjustable arms available as extra add-on
 - 3 year warranty

Finish:



Accessories
DRAFTING KIT | CH BASE

Specifications:
Drafting Kit 500 Diameter x 460H
Chrome Base 650 Diameter x 150H
Compatibility EC070CM, EG100CH, EM300, EC070BM, EC070CH, ET20

- Features:**
- Drafting kit used to create a drafting height chair to be used with drafting height table or height adjustable desk. Includes chrome foot ring for resting
 - Chrome base with a polished aluminium finish, providing a quick and easy way to upstyle your chair. *Castors not included
 - 3 year warranty

Finishes:





ERGO Air
ERGO AIR BL

Specifications:
Overall Size 520W x 510D x 1090-1150H
Seat Size 520W x 510D
Seat Height 490-580H
Weight Rating 160kg

- Features:**
- Fully ergonomic 4 lever heavy-duty mechanism with seat slide
 - Heavy-duty five star spider base with 50mm hard floor castors
 - Pneumatic lumbar pump adjustment
 - Luxurious heavy-duty moulded foam seat
 - 10 year warranty

Finish:



ERGO Midi
ERGO MIDI BL

Specifications:
Overall Size 520W x 470D x 860-1010H
Seat Size 470W x 470D
Seat Height 470-560H
Weight Rating 160kg

- Features:**
- Fully ergonomic 4 lever heavy-duty mechanism with seat slide
 - Heavy-duty five star spider base with 50mm hard floor castors
 - Luxurious heavy-duty moulded foam seat
 - 10 year warranty

Finish:



Milan Chair
MILAN MB BL

Specifications:
Overall Size 510W x 480D x 1040-1105H
Seat Size 510W x 480D
Seat Height 490-555H
Weight Rating 160kg

- Features:**
- Black height adjustable ratchet mesh back
 - Fully ergonomic 4 lever mechanism with seat slide
 - Black base with 50mm hard floor castors
 - Luxurious heavy-duty moulded foam seat in black fabric
 - 10 year warranty

Finish:



Mirae Medium
MIRAE MB BL

Specifications:
Overall Size 510W x 560D x 950-1150H
Seat Size 510W x 470D
Seat Height 490-630H
Weight Rating 160kg

- Features:**
- Fully ergonomic 4 lever heavy-duty mechanism with seat slide
 - Five star spider base with 50mm hard floor castors
 - Luxurious heavy-duty moulded foam seat
 - Height adjustable ratchet back
 - 10 year warranty

Finish:



Endeavour Chair
ENDEAVOUR PRO BL

Specifications:
Overall Size 700W x 580D x 1040-1105H
Seat Size 510W x 480D
Seat Height 490-555H
Weight Rating 160kg

- Features:**
- 4 lever heavy-duty mechanism with seat slide
 - Heavy-duty base with 50mm hard floor castors
 - Triple strip lumbar support
 - Luxurious heavy-duty moulded foam seat
 - 10 year warranty

Finish:



Endeavour PU
ENDEAVOUR PRO BPU

Specifications:
Overall Size 700W x 580D x 1040-1105H
Seat Size 510W x 470D
Seat Height 490-565H
Weight Rating 160kg

- Features:**
- Fully ergonomic 4 lever heavy-duty mechanism with seat slide
 - Back rest & luxurious heavy-duty moulded foam seat pan upholstered in antimicrobial silver ion technology black PU
 - Heavy-duty five star spider base with 50mm hard floor castors
 - 10 year warranty

Finish:



Merida High
MERIDA HB BL

Specifications:
Overall Size 600W x 520D x 1090-1230H
Seat Size 510W x 510D
Seat Height 515-585H
Weight Rating 160kg

- Features:**
- Fully ergonomic 4 lever heavy-duty mechanism with seat slide
 - Heavy-duty five star spider base with 50mm hard floor castors
 - Luxurious heavy-duty moulded foam seat
 - Height adjustable ratchet back
 - 10 year warranty

Finishes:



Accessories
ST SPIDER BASE | SL38L1

Specifications:
SL38L1 Adjustable arms
ST SPIDER BASE 700mm diameter polished aluminium base

- Features:**
- 10 year warranty on ST Spider Base
 - Both the chair base and adjustable arms suit the ERGO Air, ERGO Midi, Endeavour, Milan, Mirae, and Merida

Finishes:





Ergora Posture Chair
 ERGORA MB BL | ERGORA MB BPU

NEW

Specifications:

Overall Size 640W x 640D x 1130-1230H
 Seat Size 520W x 490D x 470-570H
 Weight Rating 120kg

Features:

- Medium back posture chair in black fabric or PU
- Dual-zone back support providing lumbar and thoracic support
- Adaptive recline mechanism and dynamic seat angle
- Seat slide and gas lift
- Arms not included, compatible with Breeze arms
- 10 year warranty

Finishes:



Monarch 24/7 Chair
 MONARCH1 GBL

NEW

Specifications:

Overall Size 710W x 690D x 1170 - 1235H
 Seat Size 560W x 470D x 460 - 525H
 Weight Rating 185kg

Features:

- Monarch heavy-duty 24/7 controller chair
- Genuine black leather, premium high-density foam cushioning
- Contoured lumbar and thoracic support for extended comfort
- Heavy-duty polished aluminium base with twin-wheel castors
- Tilt-lock and gas-lift mechanisms tested for continuous use
- Executive headrest and upholstered armrests
- Warranty: 10 years/ 8 hour use, or 2 years/ 24 hour use

Finish:



SGS

Pixel Swivel Chair
 PIX5STAR | PIX5STAR-WA

Specifications:

Overall Size 630W x 630D x 830-875H
 Seat Size 450W x 420D
 Seat Height 470-515H
 Weight Rating 120kg

Features:

- Height adjustable swivel chair with ribbed stitching detail
- Available in Light Grey fabric, Olive fabric, Amber PU, Almond PU, or French Navy PU
- 5 star base and gas strut finished in black or white powdercoat
- Arms available for additional cost
- 5 year warranty

Seat Finishes:



Pixel Sled Base
 PIXSLED

Specifications:

Overall Size 550W x 550D x 790H
 Seat Size 450W x 420D
 Seat Height 440H
 Weight Rating 120kg

Features:

- Seat pan with ribbed stitching detail
- Available in Light Grey fabric, Olive fabric, Amber PU, Almond PU, or French Navy PU
- Sled base underframe with linking abilities
- Frame in black or white powdercoat
- 5 year warranty

Seat Finishes:



Ergora with Headrest
 ERGORA HB BL | ERGORA HB BPU

NEW

Specifications:

Overall Size 640W x 640D x 1220-1320H
 Seat Size 520W x 490D x 470-570H
 Weight Rating 120kg

Features:

- High back posture chair with headrest black fabric or PU
- Dual-zone back support providing lumbar and thoracic support
- Adaptive recline mechanism and dynamic seat angle
- Seat slide and gas lift
- Arms not included, compatible with Breeze arms
- 10 year warranty

Finishes:



Pixel Tub Chair
 PIXTUB5STA

Specifications:

Overall Size 620W x 620D x 780-825H
 Seat Size 420W x 400D
 Seat Height 470-515H
 Weight Rating 120kg

Features:

- 5 star base and gas strut
- 45mm gas lift height stroke
- Available in Olive fabric or Charcoal fabric with a Black or White powdercoat base
- 5 year warranty

Finishes:

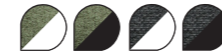

PIXSTOOL63 AMB/BL

PIXSTOOL73 OL/WS

Pixel High Stool
 PIXSTOOL63 | PIXSTOOL73

Specifications:

PIXSTOOL63 Overall Size 480W x 535D x 845H
 PIXSTOOL63 Seat Size 440W x 390D x 630H
 PIXSTOOL73 Overall Size 480W x 535D x 945H
 PIXSTOOL73 Seat Size 440W x 390D x 730H
 Weight Rating 110kg

Features:

- Seat pan with ribbed stitching detail
- Both sizes available in Light Grey fabric, Olive fabric, Amber PU, Almond PU, or French Navy PU
- Sled base with foot rail finished in black or white powdercoat
- 5 year warranty

Seat Finishes:



Pixel 4 Leg Base
 PIXTP4L

Specifications:

Overall Size 525W x 510D x 790H
 Seat Size 450W x 420D
 Seat Height 440H
 Weight Rating 120kg

Features:

- Seat pan with ribbed stitching detail
- Available in Light Grey fabric, Olive fabric, Amber PU, Almond PU, or French Navy PU
- 4 leg steel base in timber look powdercoat
- 5 year warranty

Seat Finishes:





Air Chair

AIR FBK | AIRTAB BL

Specifications:

Overall Size 640W x 555D x 835H
 Seat Size 460W x 490D x 445H
 Weight Rating 110kg

Features:

- Mesh back training chair with black fabric seat
 - Foldable with nesting capabilities
 - Fixed arm rests
 - Tablet arm sold separately
 - 5 year warranty
- *Customisable Rapidline upholstery available

Finishes:



Yoyo Stool
YOYO STOOL DG

Specifications:

Overall Size 600W x 600D x 820-1020H
 Seat Size 450W x 440D
 Seat Height 520-720H
 Weight Rating 110kg

Features:

- Height adjustable sit-stand stool with wire-control mechanism
- Moulded foam seat and back finished in dark grey fabric
- Nylon base with castors and footring
- 10 year warranty

Finish:



DS Desk Stool
DS DESK

Specifications:

Overall Size 600 Diameter x 450-570H
 Seat Size 400 Diameter
 Seat Height 450-570H
 Weight Rating 100kg

Features:

- 400mm round seat, height adjustable, desk stool
- Easy to clean black PU material
- Black spider base
- 3 year warranty

Finish:



DS Counter Stool
DS COUNTER

Specifications:

Overall Size 600 Diameter x 650-870H
 Seat Size 400 Diameter
 Seat Height 650-870H
 Weight Rating 100kg

Features:

- 400mm round seat, height adjustable, counter stool
- Chrome finish drafting ring
- Easy to clean black PU material
- Black spider base
- 3 year warranty

Finish:



Wimbledon Chair

WIMBLEDON | WSP | WBP | WTAB

Specifications:

Overall Size 435W x 460D x 785H
 Seat Size 425W x 430D x 440H
 Weight Rating 120kg

Features:

- Plastic seat and back in a black finish
 - Chrome sled base
 - Linkable and stackable
 - Tablet arm and seat/back pads sold separately
 - 3 year warranty
- *Customisable Rapidline upholstery available for pads only

Finish:



Wimbledon + Arms
WIMBLEDON WITH ARMS

Specifications:

Overall Size 450W x 460D x 785H
 Seat Size 425W x 430D x 440H
 Arm Size 30W x 285D x 205H
 Weight Rating 120kg

Features:

- Black plastic seat and back, chair comes with fixed arms
 - Chrome sled base
 - Linkable and stackable chair
 - Seat and back pads sold separately
 - 3 year warranty
- *Customisable Rapidline upholstery available for pads only

Finish:



Lab Chair
LAB CH

Specifications:

Overall Size 470W x 430D x 845-960H
 Seat Size 470W x 435D
 Seat Height 420-540H
 Weight Rating 110kg

Features:

- Height adjustable laboratory chair with seat and back tilt
- Moulded polyurethane finished in black
- Contoured waterfall seat pan
- 5 year warranty

Finish:



Lab Stool
LAB ST

Specifications:

Overall Size 470W x 500D x 965-1185H
 Seat Size 460W x 440D
 Seat Height 640-850H
 Weight Rating 130kg

Features:

- Height adjustable stool with chrome drafting ring
- Moulded polyurethane finished in black
- Contoured waterfall seat pan
- Tilting back rest with infinite lock
- 5 year warranty

Finish:





Academy Chair
ACADCHA BK | ACADCHA WH

NEW

Specifications:

Overall Size 530W x 530D x 800H
Seat Size 445W x 490D x 460H
Weight Rating 135kg

Features:

- Fully moulded robust polypropylene shell
- Stackable design up to 10 chairs
- UV stabilised
- Seat pad and linking mechanism available for extra
- 10 year warranty

Finishes:



Academy Chair with Seat Pad
ACAD-WSP

NEW

Specifications:

Seat Pad 410D x 440W
Weight Rating 135kg

Features:

- Academy chair with upholstered seat pad
- Seat pad available in black, light grey, or emerald green fabric
- 3 year warranty on seat pad, 10 year warranty on chair

Finishes:



Arlo Chair
ARLOCH NF

NEW

Specifications:

Overall Size 470W x 468D x 760H
Seat Size 453W x 420D x 460H
Back Size 470W x 300H
Weight Rating 160kg

Features:

- Made from FSC certified American Oak timber
- Natural finish
- 3 year warranty

Finish:



Nodo Chair
NODOCH NF

NEW

Specifications:

Overall Size 468W x 525D x 795H
Seat Size 468W x 468D x 435H
Back Size 468W x 370H
Weight Rating 160kg

Features:

- Made from FSC certified American Oak timber
- Natural finish
- 3 year warranty

Finish:



Academy Chair with Tablet Arm
ACAD-WTARM | ACAD-TA-SP

NEW

Specifications:

Tablet Size 348W x 230D
ACAD-WTARM Chair with tablet arm
ACAD-TA-SP Chair with tablet arm and seat pad

Features:

- Tablet mounts as right hand arm only
- Tablet has swivel, tilt and flip functions
- Linking mechanism available for extra
- 10 year warranty

Finishes:



Academy Add-Ons
ACADLINK

NEW

Specifications:

ACADLINK BK Linking mechanism block in Black
ACADLINK WH Linking mechanism block in White

Features:

- Linking block comes as single piece, use with Academy chair
- Chair not included
- 10 year warranty

Finishes:



Arlo Stool
ARLOHS76 NF

NEW

Specifications:

Overall Size 466W x 476D x 1050H
Seat Size 453W x 450D x 760H
Back Size 466W x 300H
Weight Rating 160kg

Features:

- Made from FSC certified American Oak timber
- Natural finish
- 3 year warranty

Finish:



Nodo Stool
NODOHS76 NF

NEW

Specifications:

Overall Size 468W x 580D x 1110H
Seat Size 468W x 468D x 755H
Back Size 468W x 370H
Weight Rating 160kg

Features:

- Made from FSC certified American Oak timber
- Natural finish
- 3 year warranty

Finish:





Hera Breakout Chair
HERA

Specifications:

Overall Size 640W x 570D x 780H
 Seat Size 550W x 510D x 465H
 Weight Rating 135kg

Features:

- Robust steel 4 leg frame finished in black powdercoat
- Leather finish in Amber PU or French Navy PU
- Moulded foam seat and back rest
- 5 year warranty

Finishes:



Eros Breakout Chair
EROS

Specifications:

Overall Size 530W x 580D x 830H
 Seat Size 490W x 435D x 445H
 Weight Rating 120kg

Features:

- Robust steel 4 leg frame finished in black powdercoat
- Leather finish in Amber PU or French Navy PU
- Moulded foam seat and back rest
- 5 year warranty

Finishes:



Eros Stool
EROS-HS750

Specifications:

Overall Size 450W x 465D x 835H
 Seat Size 405W x 380D
 Seat Height 725H
 Weight Rating 135kg

Features:

- Bar stool with rounded foot rest
- Commercial-grade fabric available in Olive, Charcoal, Rust, and Stone
- Black powdercoat base
- 5 year warranty

Finishes:



Aries Stool
ARIES STOOL

Specifications:

Overall Size 455W x 545D x 853H
 Seat Size 440W x 450D x 760H
 Weight Rating 110kg

Features:

- Stylish black metal curved frame with leg rest
- Polypropylene plastic seat pan
- Seat available in black or grey
- 3 year warranty

Finishes:



Nyx Breakout Chair
NYX AMB | NYX FN

Specifications:

Overall Size 490W x 520D x 760H
 Seat Size 470W x 470D x 470H
 Weight Rating 120kg

Features:

- Robust steel 4 leg frame finished in black powdercoat
- Leather finish in Amber PU or French Navy PU
- Moulded foam seat and back rest
- 5 year warranty

Finishes:



Nyx 650mm Stool
NYX-650 AMB | NYX-650 FN

NEW

Specifications:

Overall Size 512W x 512D x 955H
 Seat Size 475W x 435D x 650H
 Foot Ring 512Dia. x 300H
 Weight Rating 120kg

Features:

- Robust steel 4 leg frame finished in black powdercoat
- Leather finish in Amber PU or French Navy PU
- Moulded foam seat and back rest
- 5 year warranty

Finishes:



Nyx 750mm Stool
NYX-HS750 AMB | NYX-HS750 FN

NEW

Specifications:

Overall Size 532W x 532D x 1055H
 Seat Size 475W x 435D x 750H
 Foot Ring 532Dia. x 300H
 Weight Rating 120kg

Features:

- Robust steel 4 leg frame finished in black powdercoat
- Leather finish in Amber PU or French Navy PU
- Moulded foam seat and back rest
- 5 year warranty

Finishes:



Virgo Stool
VIRGO STOOL

Specifications:

Overall Size 475W x 475D x 820H
 Seat Size 440W x 450D x 770H
 Weight Rating 110kg

Features:

- Modern bar stool with an oak coloured frame
- Curved polypropylene plastic seat pan
- Seat available in black or grey
- 3 year warranty

Finishes:





Apollo Chair
APOLLO BL

NEW

Specifications:

Overall Size 485W x 505D x 800H
Seat Size 440W x 410D x 455H
Weight Rating 150kg

Features:

- Heavy duty stacking chair
- Black polypropylene seat and back rest
- Robust solid steel sled base frame in black powdercoat
- Nylon glides with linking feature
- 7 year warranty

Finishes:



Apollo With Seat Pad
APOLLOWP BL/BPU

NEW

Specifications:

Overall Size 485W x 505D x 800H
Seat Size 440W x 410D x 455H
Weight Rating 150kg

Features:

- Heavy duty stacking chair with seat pad upholstered in black vinyl
- Black polypropylene seat and back rest
- Robust solid steel sled base frame in black powdercoat
- Nylon glides with linking feature
- 7 year warranty

Finishes:



Vivid Chair
VIVID BL | VIVID WH

Specifications:

Overall Size 455W x 510D x 820H
Seat Size 455W x 470D x 460H
Weight Rating 120kg

Features:

- Large polypropylene shell seat finished in black or white
- Powdercoat steel sled base in black or white
- Nylon glides under frame
- Stackable up to 15 chairs high
- 5 year warranty

Finishes:



Zola Chair
ZOLA

Specifications:

Overall Size 460W x 500D x 800H
Seat Size 460W x 440D x 430H
Weight Rating 100kg

Features:

- Black plastic seat and black curved back
- Chrome frame with sled base
- Stackable up to 15 chairs
- 3 year warranty

Finish:



Lucid Chair
LUCID

Specifications:

Overall Size 500W x 500D x 795H
Seat Size 440W x 400D x 450H
Weight Rating 110kg

Features:

- Polypropylene chair with concealed feet buttons
- Textured seat and back available in black or white
- Mix and match seats with black plastic and timber bases
- 3 year warranty

Seat Finishes:



Base Finishes:



Apollo Trolley
APOLLOTROL BL

NEW

Specifications:

Overall Size 733W x 454D x 610H
Weight rating Maximum of 25 chairs
Compatibility APOLLO BL, APOLLOWP BL/BPU

Features:

- Convenient storage and transportation for Apollo chairs
- Finished in black powdercoat
- 5 year warranty

Finishes:



Zing Chair
ZING

Specifications:

Overall Size 500W x 520D x 830H
Seat Size 465W x 430D x 440H
Weight Rating 120kg

Features:

- Large black plastic back and seat
- Linkable and stackable chair with chrome sled base with feet
- 3 year warranty

Finish:



PMV-BK Chair
PMV- BK

Specifications:

Overall Size 530W x 460D x 810H
Seat Size 455W x 460D x 450H
Weight Rating 110kg

Features:

- Black mesh back chair with black plastic seat
- Stackable with linking feature
- Chrome sled base and frame
- 5 year warranty

Finish:





Endura Visitor Chair
ENDURAV BL | ENDURAV ARMS BL

NEW

Specifications:

Overall Size 520W x 630D x 850H
Seat Size 470W x 510D x 475H
Weight Rating 135kg

Features:

- Sturdy black powdercoated steel frame
- Upholstered in black fabric
- Add-on arms available for extra
- 5 year warranty

Finish:



Endura Max Bariatric
ENDURAMAX300 BL

NEW

Specifications:

Overall Size 880W x 650D x 810H
Seat Size 790W x 470D x 450H
Weight Rating 300kg

Features:

- Heavy duty visitor chair
- Reinforced steel frame and wider seat dimensions
- Best for bariatric, healthcare & public high-traffic environments
- 5 year warranty

Finish:



WMV BK Chair
WMV BK

Specifications:

Overall Size 570W x 460D x 890H
Seat Size 480W x 480D x 480H
Weight Rating 120kg

Features:

- Black mesh back and black fabric seat
- Chrome frame and legs
- Curved plastic arm rests
- 5 year warranty
- *Customisable Rapidline seat upholstery available

Finishes:



SGS

WMCC Chair
WMCC

Specifications:

Overall Size 625W x 620D x 940H
Seat Size 470W x 470D x 440H
Weight Rating 110kg

Features:

- Cantilever chrome base chair with fixed arms
- Black fabric seat
- Comfortable mesh material on back
- 5 year warranty
- *Customisable Rapidline seat upholstery available

Finishes:



V100 Chair
V100 BL

Specifications:

Overall Size 500W x 450D x 800H
Seat Size 450W x 450D x 460H
Weight Rating 120kg

Features:

- Comfortable black fabric seat with black frame
- Stackable up to 15 chairs
- 3 year warranty

Finish:



BIFMA COMPLIANT

Nova Chair
NOVA BL | NOVA BPU

Specifications:

Overall Size 550W x 530D x 760H
Seat Size 448W x 444D x 445H
Weight Rating 110kg

Features:

- Stackable, linkable chair
- Black powdercoated frame
- 3 year warranty

Finishes:





P100 Chair
P 100 B

Specifications:
Overall Size 450W x 370D x 845H
Seat Size 450W x 370D x 440H
Weight Rating 120kg

- Features:**
- Black polypropylene plastic chair with a sturdy black frame
 - Ventilation hole in back
 - Stackable up to 15 chairs
 - 3 year warranty

Finish: 



EVO Chair
EVO BL | EVO BPU

Specifications:
Overall Size 480W x 500D x 840H
Seat Size 455W x 450D x 460H
Weight Rating 110kg

- Features:**
- Sled base chair with cushioned seat and back
 - Fire retardant foam seats available in black fabric or PU
 - Chrome tube frame
 - Stackable up to 5 chairs high, stacks 20 high on chair trolley
 - 3 year warranty

Finishes: 



Frame Chair
FRAME BL

Specifications:
Overall Size 470W x 500D x 790H
Seat Size 420W x 410D x 455H
Weight Rating 120kg

- Features:**
- Perforated back rest and polypropylene seat
 - Stackable with linking feature
 - Solid rod base
 - 10 year warranty

Finish: 



Z Trolley
Z TROLLEY

Specifications:
Overall Size 800W x 620D x 440H
Weight Rating Maximum of 30 chairs
Compatibility PMVBK, FRAME BL, ZING, ZOLA, WIMBLEDON

- Features:**
- Convenient method of storage and transportation of chairs
 - 3 year warranty

Finish: 

CHAIR & SCREEN UPHOLSTERY

We have proudly partnered with leading commercial-grade fabric manufacturers to bring you the following thoughtfully curated palette of fabric ranges for custom upholstery options. Available for a selection of our Rapidline range.



Sensation Woven



CUSTOMISABLE CHAIRS

- AIR
- BREEZE
- ECO70CH
- ECO70CM
- EG100
- EM300
- ET20
- ERGO TASK
- GCAD (Cushion only)
- GMP3 (Cushion only)
- GUST
- HARTLEY TASK
- HARTLEY VISITOR
- KAL
- LOTTO (Seat pan only)
- LUMINOUS
- KALI OTTOMANS
- WIMBLEDON (Back & seat pad)
- WMCC
- WMVBK

CUSTOMISABLE SCREENS

- SHUSH30+ Screens
- Freestanding Acoustic Screens
- Infinity Screens
- Eternity Screens
- BOOST+ Screens

OUTDOOR RANGE



Ridge Table ODT

NEW

Specifications:
 ODT8484 EO/BK 835W x 835D x 750H
 ODT18590 EO/BK 1850W x 900D x 750H
 ODT23090 EO/BK 2300W x 900D x 750H

- Features:**
- Aluminium base with black powdercoat finish
 - Stainless steel hardware
 - European Oak finish Polywood slats
 - Adjustable leveling feet
 - Available in 3 sizes
 - 3 year structural warranty

Finishes:



Ridge Bench Seat ODB

NEW

Specifications:
 ODB16935 EO/BK 1690W x 350D x 460H
 ODB21435 EO/BK 2140W x 350D x 460H

- Features:**
- Aluminium base with black powdercoat finish
 - Stainless steel hardware
 - European Oak finish Polywood slats
 - Adjustable leveling feet
 - Available in 2 sizes
 - 3 year structural warranty

Finishes:



Medium Picnic Table ODTB180166 EO/BK

NEW

Specifications:
 Overall Size 1800W x 1660D x 750H
 Table Size 1800W x 680D x 750H
 Bench Size 1800W x 340D x 470H

- Features:**
- Aluminium base with black powdercoat finish
 - Stainless steel hardware
 - European Oak finish Polywood slats
 - Adjustable leveling feet
 - 3 year structural warranty

Finishes:



Large Picnic Table ODTB220190 EO/BK

NEW

Specifications:
 Overall Size 2200W x 1900D x 750H
 Table Size 2200W x 900D x 750H
 Bench Size 2200W x 340D x 470H

- Features:**
- Aluminium base with black powdercoat finish
 - Stainless steel hardware
 - European Oak finish Polywood slats
 - Adjustable leveling feet
 - 3 year structural warranty

Finishes:





Flexi Stacking Chair
FLXSHEL

NEW

Specifications:

Overall Size 485W x 550D x 690H
Seat Size 420W x 460D x 440H
Weight Rating 135kg

Features:

- UV treatment suitable for outdoor use (1 year warranty)
- Flexi stacker range with add-on back rests for extra
- Use chair without backrest as a junior stacking chair
- Available in white, grey or green
- Mix and match back rest colour and seat colours
- Stacks up to 6 chairs high
- 5 year warranty

Finishes:



Flexi with Backrest
FLEXI

NEW

Specifications:

Chair with Backrest 485W x 550D x 815H
Backrest Size 430W x 310H
Weight Rating 135kg

Features:

- UV treatment suitable for outdoor use (1 year warranty)
- Detachable back rest
- Available in white, grey or green
- Stacks up to 6 chairs high
- 5 year warranty

Finishes:



Pippee Chair
PIPPEE

Specifications:

Overall Size 400W x 380D x 860H
Seat Size 400W x 380D x 450H
Weight Rating 150kg

Features:

- Stackable, polypropylene plastic chair in white or grey
- High lustre shine
- Holds up to 150kg under intended use
- 3 year warranty

Finishes:



Cast Stool
CAST-650ST

Specifications:

Overall Size 440W x 510D x 960H
Seat Size 440W x 370D x 650H
Weight Rating 135kg

Features:

- Stool to suit the Cast range
- Suitable for outdoor use
- UV Stabilised
- Available in black or white
- 3 year warranty

Finishes:



Cast Chair
CAST-450CH

Specifications:

Overall Size 500W x 640D x 830H
Seat Size 500W x 440D x 450H
Weight Rating 150kg

Features:

- Breakout chair to suit the Cast range
- Suitable for outdoor use
- UV Stabilised
- Available in black or white
- 3 year warranty

Finishes:



Cast High Stool
CAST-H750ST

Specifications:

Overall Size 440W x 510D x 1060H
Seat Size 440W x 370D x 750H
Weight Rating 135kg

Features:

- High stool to suit the Cast range
- Suitable for outdoor use
- UV Stabilised
- Available in black or white
- 3 year warranty

Finishes:



STORAGE & ACCESSORIES



Carpet Chair Mat MAT S | MAT L

Specifications:

MAT S	915W x 1200D x 2H
MAT L	1150W x 1350D x 2H

Features:

- Composition: PVC - 75%, DDTP (PVC plasticizer) - 20%, ABS - 2%, stabilizer - 2%, colour pigment - 1%
- Dimpled mat for low pile carpet floors
- Tested for fire retardancy
- Clear finish
- 5 year warranty

Finish:



Hard Floor Chair Mat MAT SMOOTH S | MAT SMOOTH L

Specifications:

MAT SMOOTH S	915W x 1200D x 2H
MAT SMOOTH L	1150W x 1350D x 2H

Features:

- Composition: - PVC - 75%, DDTP (PVC plasticizer) - 20%, ABS - 2%, stabilizer - 2%, colour pigment - 1%
- Use for hard floors
- Tested for fire retardancy
- Clear finish
- 5 year warranty

Finish:



Utility Trolley TR3

Specifications:

Overall Size	800W x 600D x 900H
Weight Rating	100kg

Features:

- Utility trolley in Ironstone finish
- 3 tiers of storage space
- Castor wheels for ease of movement
- Strong, sturdy frame
- 5 year warranty

Finish:



Corner Lozenge LOZENGE25 | LOZENGE33

Specifications:

LOZENGE25 GR	For 25mm thick desks - 250W x 480D
LOZENGE33 GR	For 33mm thick desks - 250W x 480D

Features:

- Converts desk and return to a corner workstation
- Adds diagonal for user to comfortably sit at
- Fits 25mm or 33mm deep melamine tops
- 5 year warranty

Finish:



HEIGHT ADJUSTABLE ACCESSORIES



HEIGHT ADJUSTABLE ACCESSORIES



Rapid Flux RF1 | RF2

Specifications:
 RF1 Overall Size 880W x 600D x 120-505H
 RF2 Overall Size 950W x 600D x 120-505H
 Work Surface 415D
 Weight Capacity 25kg on top

Features:

- Electric height adjustable solution for fixed desk
- Adjusts at 22mm per second speed
- Hidden motor makes for a compact design
- Grommet hole in worktop for use with monitor arms
- 5 year warranty

Finish:



Rapid Riser RR2

Specifications:
 Work Surface 890W x 590D x 150-500H
 Weight Capacity 18kg

Features:

- Manual height adjustable solution for fixed desk
- 15 different height level settings
- Comes with hole for monitor arm installation
- 10 year warranty

Finishes:



Refresh Mat RRM BL

Specifications:
 Overall Size 985W x 505D x 19H

Features:

- Anti-fatigue mat
- 100% PU material
- Use with any height adjustable solution
- 10 year warranty

Finish:



Digital Lock
DIGIPRILOCK | DIGIPUBLOCK

- Features:**
- Digital keypad code lock
 - Can be used with melamine or steel lockers as optional extra
 - Public or private lock programming
 - Black finish only
 - 1 year warranty
 - *Batteries not included

Options:

Product Code	Width	Depth	Height	Programming
DIGIPRILOCK	38mm	60mm	95mm	Private
DIGIPUBLOCK	38mm	60mm	95mm	Public



Finish:



Step Door Locker
SDWRML-380/2

- Features:**
- MR melamine carcass with MDF doors
 - Soft close hinges on doors - key lock with 2 x keys per lock
 - Adjustable leveling feet
 - 1 x hanging rail per compartment
 - Available in Natural White or Natural Oak
 - 3 year warranty

Options:

Product Code	Width	Depth	Height	Colour
SDWRML-380/2 NO/BL	380mm	455mm	1850mm	Natural Oak
SDWRML-380/2 NW/BL	380mm	455mm	1850mm	Natural White



Finishes:



1 Door Locker
WRML-305/1

- Features:**
- MR melamine carcass with MDF doors
 - Soft close hinges on doors - key lock with 2 x keys per lock
 - Adjustable leveling feet
 - 1 x hanging rail and 1 x hat shelf
 - Available in Natural White or Natural Oak
 - 3 year warranty

Options:

Product Code	Width	Depth	Height	Colour
WRML-305/1 NO/BL	305mm	455mm	1850mm	Natural Oak
WRML-305/1 NW/BL	305mm	455mm	1850mm	Natural White

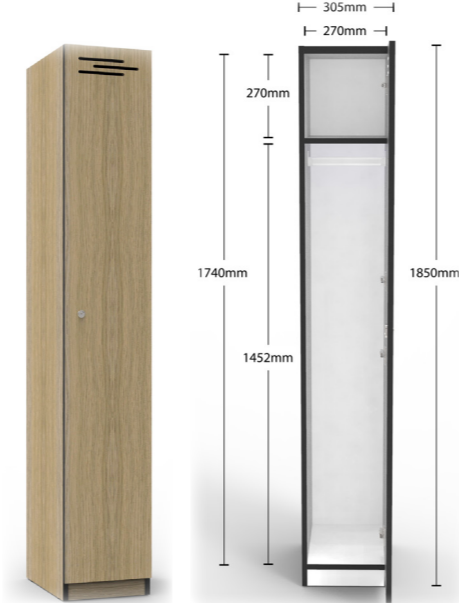

Finishes:



2 Door Locker
WRML-305/2

- Features:**
- MR melamine carcass with MDF doors
 - Soft close hinges on doors - key lock with 2 x keys per lock
 - Adjustable leveling feet
 - 1 x hanging rail per compartment
 - Available in Natural White or Natural Oak
 - 3 year warranty

Options:

Product Code	Width	Depth	Height	Colour
WRML-305/2 NO/BL	305mm	455mm	1850mm	Natural Oak
WRML-305/2 NW/BL	305mm	455mm	1850mm	Natural White



Finishes:



3 Door Locker
WRML-305/3

- Features:**
- MR melamine carcass with MDF doors
 - Soft close hinges on doors - key lock with 2 x keys per lock
 - Adjustable leveling feet
 - 3 x locker compartments
 - Available in Natural White or Natural Oak
 - 3 year warranty

Options:

Product Code	Width	Depth	Height	Colour
WRML-305/3 NO/BL	305mm	455mm	1850mm	Natural Oak
WRML-305/3 NW/BL	305mm	455mm	1850mm	Natural White



Finishes:



4 Door Locker
WRML-305/4

- Features:**
- MR melamine carcass with MDF doors
 - Soft close hinges on doors - key lock with 2 x keys per lock
 - Adjustable leveling feet
 - 4 x locker compartments
 - Available in Natural White or Natural Oak
 - 3 year warranty

Options:

Product Code	Width	Depth	Height	Colour
WRML-305/4 NO/BL	305mm	455mm	1850mm	Natural Oak
WRML-305/4 NW/BL	305mm	455mm	1850mm	Natural White

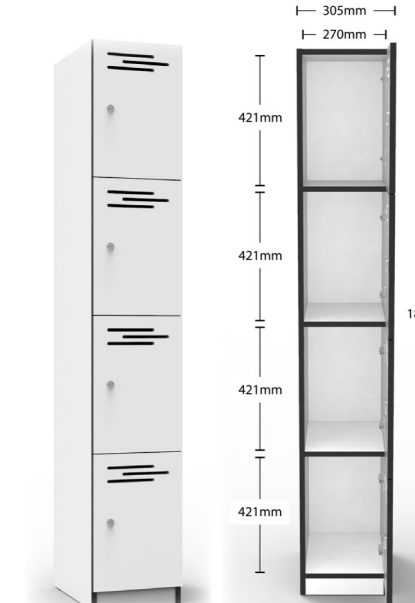

Finishes:



GO Locker Sloping Top

G12830 | G32830

Features:

- Sloping top in Silver Grey only
- Use with either a single locker or bank of 3 lockers
- Suitable for 305mm wide lockers only
- Neat and easy to clean with 30° degree sloping top
- Stop debris from collecting above lockers
- 10 year warranty

Specifications:

Product Code	Overall Size	Function
G12830	300W x 457D x 270H	Use with single 305W locker
G32830	900W x 457D x 270H	Use with bank of 3 x 305W lockers



G12830



G32830 shown on 3 x 305W lockers

Finish:



GO Step Door Locker

GSL380

Features:

- Riveted construction for extra strength
- Name tag holder and vented doors
- 1 x hanging rail per compartment
- Full length stiffeners fitted to each door for rigidity
- Comes in Silver Grey only
- Master key series
- 10 year warranty

Specifications:

Product Code	Width	Depth	Height	Colour
GSL380	390mm	455mm	1840mm	Silver Grey



Finish:



GO Single Door Locker

GL305/1 | GL380/1

Features:

- Riveted construction for extra strength
- Name tag holder and vented doors
- 1 x hat shelf, 1 x coat rail storage
- Full length stiffeners fitted to each door for rigidity
- Comes in Silver Grey - 305mm wide units also available in white
- Master key series
- 10 year warranty

Options:

Product Code	Width	Depth	Height	Colour
GL305/1	305mm	455mm	1830mm	Silver Grey or White
GL380/1	380mm	455mm	1830mm	Silver Grey Only



Finishes:



GO 2 Door Locker

GL305/2 | GL380/2

Features:

- Riveted construction for extra strength
- Name tag holder and vented doors
- 1 x coat hook per compartment
- Full length stiffeners fitted to each door for rigidity
- Comes in Silver Grey - 305mm wide units also available in white
- Master key series
- 10 year warranty

Options:

Product Code	Width	Depth	Height	Colour
GL305/2	305mm	455mm	1830mm	Silver Grey or White
GL380/2	380mm	455mm	1830mm	Silver Grey Only



Finishes:



GO 3 Door Locker

GL305/3 | GL380/3

NEW

Features:

- Riveted construction for extra strength
- Name tag holder and vented doors
- Full length stiffeners fitted to each door for rigidity
- Comes in Silver Grey - 305mm wide units also available in white
- Master key series
- 10 year warranty

Options:

Product Code	Width	Depth	Height	Colour
GL305/3	305mm	455mm	1830mm	Silver Grey or White
GL380/3	380mm	455mm	1830mm	Silver Grey Only



Finishes:



GO 4 Door Locker

GL305/4 | GL380/4

Features:

- Riveted construction for extra strength
- Name tag holder and vented doors
- Full length stiffeners fitted to each door for rigidity
- Comes in Silver Grey - 305mm wide units also available in white
- Master key series
- 10 year warranty

Options:

Product Code	Width	Depth	Height	Colour
GL305/4	305mm	455mm	1830mm	Silver Grey or White
GL380/4	380mm	455mm	1830mm	Silver Grey Only



Finishes:



Steel Mesh Single Door Locker
SML-305/1 GR

NEW

Features:

- Finished in Graphite Ripple
- Lockable - supplied with 2 x keys
- Adjustable leveling feet
- Fixed height hat shelf
- Hanging rail
- 10 year warranty

Specifications:

	Width	Depth	Height	Colour
1 Door	305mm	455mm	1830mm	Graphite Ripple

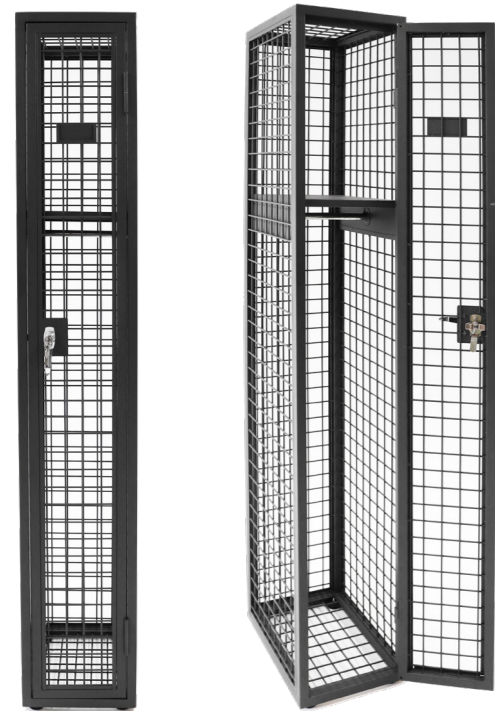

Finish:



Steel Mesh 3-Door Locker
SML-915/3 GR

NEW

Features:

- Finished in Graphite Ripple
- Lockable - supplied with 2 x keys
- Adjustable leveling feet
- Fixed height hat shelf
- Hanging rail
- 10 year warranty

Specifications:

	Width	Depth	Height	Colour
3 Door	915mm	455mm	1830mm	Graphite Ripple



Finish:



Locker Stands
GLST | GSS

Specifications:

- GLST610-305 For 2 lockers - 610W x 455D x 150H
- GLST915-305 For 3 lockers - 915W x 455D x 150H
- GSS610-305 For 2 lockers - 610W x 895D x 450H
- GSS915-305 For 3 lockers - 915W x 895D x 450H

Features:

- Raises lockers off floor to allow for easy cleaning and/or seating
- Locker stands and seats to bank 2 or 3 lockers
- Suitable for 305mm wide lockers only
- Black powdercoat frame
- Teak coloured ModWood timber slats
- 3 year warranty

Finishes:



Butterfly Lock
BUTTERFLY LOCK

Specifications:

Padlock Requirements: Suitable for use with padlock shafts 6mm-8mm and shackle 25mm-30mm

Features:

- Butterfly lock for use with all GO Steel lockers to enable padlock facility on doors (padlock not included)
- Supplied fitted to lockers when ordered simultaneously
- 10 year warranty

Finish:



Single Bench Seat
GBS-1200

Specifications:

Overall Size 1200W x 450D x 450H

Features:

- Single sided bench seat
- Teak coloured ModWood timber slats
- Black powdercoat frame
- Adjustable leveling feet with bolt down provisions
- 3 year warranty

Finish:



Bench + Hanging Rail
GBOHR-1500 TEAK/BK

NEW

Specifications:

Overall Size 1500W x 1500H x 450D
Seat height 450H

Features:

- Bench seat with overhead hanging rail
- Teak coloured ModWood timber slats
- Adjustable leveling feet with bolt down provision
- 3 year warranty

Finish:



2 Drawer Ped

Features:

- 1 personal drawer and 1 file drawer
- Ball bearing runners and 5th wheel for added stability
- Designed for use with height adjustable workstations that meet AS/NZS 4442:2018 height range
- 0.7mm steel gauge
- Lockable drawers, master key locking series
- Available in white or black powdercoat
- 10 year warranty

Specifications:

Product Code	GMP1D1F
Overall Size	392W x 472D x 525H
Top Drawer Size	325W x 415D x 80H
Filing Drawer Size	325W x 415D x 245H
Weight Rating	30kgs per Drawer



Finishes:



GO Steel Slimline Ped

Features:

- Slimline to suit all workstation sizes
- Lockable drawers - supplied with 2 keys
- Stores foolscap files side to side
- Ball bearing runners
- Fifth wheel for stability
- Flush drawer front
- 10 year warranty

Specifications:

Product Code	GSP3
Overall Size	300W x 472D x 610H
Top Drawer Size	230W x 460D x 65H
Filing Drawer Size	230W x 460D x 250H
Weight Rating	30kgs per Drawer



Finishes:



GO Steel Mobile Ped

Features:

- Use with larger workstations
- Lockable drawers - supplied with 2 keys
- Stores foolscap files back to front
- Full extension ball bearing runners
- Fifth wheel for stability
- Flush drawer front
- Available in Black Ripple, Graphite Ripple, Precious Silver or White China
- 10 year warranty

Specifications:

Product Code	GMP3
Overall Size	460W x 475D x 610H
Top Drawer Size	390W x 475D x 65H
Filing Drawer Size	390W x 475D x 250H
Weight Rating	30kgs per Drawer



Finishes:



Eternity Slimline Ped

EMP3

NEW

Specifications:

Overall Size 300W x 535D x 580H

Features:

- Slimline to suit all workstation sizes
- Master key locking series
- Fifth wheel for stability
- 110kg weight rating on overall unit
- 2 personal drawers and 1 filing drawer
- Finished in black or white powdercoat
- 10 year warranty

Finish:



Mobile Ped Cushions

Specifications:

Overall Size 460W x 475D x 40 Thick

Features:

- Fabric seat cushion
- Made to suit GMP3 mobile ped
- Turn your mobile ped into convenient short-term seating
- Height of GMP3 with cushion - 660mm
- *Available in customisable Rapidline upholstery colours
- *Cushion only - mobile ped not included

Finishes:



GO Mobile Caddy

GCADN

Specifications:

Overall Size 1050W x 500D x 618H
Weight Capacity 30kgs per Drawer

Features:

- On castors, with 5th wheel on file drawer
- Lockable pedestal and tambour door with 2 keys supplied
- 2 drawers and 1 file drawer, files run front to back
- Tambour section with adjustable shelf
- GCADN-L - tambour door on left-hand side
- GCADN-R - tambour door on right-hand side
- 10 year warranty

Finishes:



Caddy Cushions

Specifications:

Overall Size 460W x 460D x 40 Thick

Features:

- Fabric seat cushion
- Made to suit GCAD caddy unit
- Turn your mobile caddy into convenient short-term seating
- Height of GCAD with cushion - 610mm
- *Available in customisable Rapidline upholstery colours
- *Cushion only - mobile caddy not included

Finishes:



Perforated Sliding Door Cupboard

- Features:**
- GO perforated sliding door cupboard
 - Includes 2 x adjustable shelves - 1 on each side
 - Perforated door feature with internal acoustic panel for sound absorption
 - Adjustable leveling feet
 - Soft closing track system
 - Lockable doors - 2 keys supplied
 - 0.7mm cold roll steel plate for carcass and 0.8mm for doors
 - 10 year warranty
 - Additional shelves available in black or white powdercoat to suit

Options:

Product Code	Width	Depth	Height	Colour
PSDC1015 WC	1530mm	473mm	1016mm	White China
PSDC1015 BL	1530mm	473mm	1016mm	Black



1500W Planter Box

- Features:**
- Planter box to suit GO perforated sliding door cupboard
 - 4 x plant pot holes
 - 0.7mm steel gauge used throughout
 - 10 year warranty
 - Cupboard, plants and pots not included

Options:

Product Code	Width	Depth	Height	Colour
PB1500 WC	1530mm	473mm	230mm	White China
PB1500 BL	1530mm	473mm	230mm	Black



Plant Pots

NEW

- Features:**
- Set of 4 plant pots
 - To suit PB900, PB1200 and PB1500 planter boxes
 - 3 year warranty

Options:

Product Code	Diameter	Height	Finish
PP41917 WH	195mm	175mm	White
PP41917 BL	195mm	175mm	Black



GO Vertical Filing Cabinet

- Features:**
- Lockable drawers - supplied with 2 keys
 - Heavy-duty and fully riveted
 - Ball bearing runners
 - 40kg weight capacity per drawer
 - Available in Black Ripple, Graphite Ripple, Precious Silver, or White China
 - 10 year warranty

Options:

Product Code	Width	Depth	Height	Drawers
GFCA2	460mm	620mm	705mm	2
GFCA3	460mm	620mm	1016mm	3
GFCA4	460mm	620mm	1321mm	4



GO Steel Lateral Filing

- Features:**
- Lockable drawers - supplied with 2 keys
 - Riveted construction for extra strength
 - Heavy-duty and anti-tilt
 - 2 rows of folders per drawer
 - Available in white or black powdercoat
 - 10 year warranty

Specifications:

Product Code	Width	Depth	Height	Drawers
GLF2	900mm	473mm	705mm	2
GLF3	900mm	473mm	1016mm	3
GLF4	900mm	473mm	1321mm	4



GO Tambour Cupboard

Features:

- Fully riveted unit for extra strength
- Fully lockable with 2 keys supplied (master series)
- Easy glide door track with magnetic anti-slam rail keeps doors closed
- Adjustable feet for leveling
- Optional extra shelves and range of accessories available
- Available in white or black finishes
- 10 year warranty

*Tambour door cupboard unit only, shelves sold separately

Options:

Product Code	Width	Depth	Height
GTD109-N	900mm	473mm	1016mm
GTD129-N	900mm	473mm	1200mm
GTD199-N	900mm	473mm	1981mm
GTD1012-N	1200mm	473mm	1016mm
GTD1212-N	1200mm	473mm	1200mm
GTD1912-N	1200mm	473mm	1981mm



Finishes:



GO Tambour Shelf

Features:

- Standard shelf to use with tambour door cupboards
- Easy to install - clips supplied
- Easy to adjust to different heights
- Available in 2 widths to suit Rapidline tambour door cupboards
- Available in white or black finishes
- 10 year warranty

Options:

Product Code	To Suit	Depth	Height
GTD900	900W Tambour unit	470mm	30mm
GTD1200	1200W Tambour unit	470mm	30mm



Finishes:



GO Planter Box

Features:

- Space for 3 x 200mm plant pots (plants and pots not included)
- Incorporated drip tray
- Use on top of tambour door cupboards or lateral filing cabinets
- Available in 2 widths to suit Rapidline tambour door cupboards
- Available in white or black finishes
- 10 year warranty

Options:

Product Code	Width	Depth	Height	To Suit
PB900	900mm	473mm	230mm	900W Tambour unit
PB1200	1200mm	473mm	230mm	1200W Tambour unit



Finishes:



GO Pull Out Shelf

Features:

- Pull out shelf for use in tambour door cupboard units
- Shelf slides out for easy operation
- Available in white only
- 10 year warranty

Options:

Product Code	To Suit	Depth	Height
GG09PS	900W Tambour unit	470mm	30mm
GG12PS	1200W Tambour unit	470mm	30mm



Finish:



GO Roll Out Shelf

Features:

- Store foolscap folders and roll out for easy access to files
- GG09FF to suit 900mm wide unit can take 1 row of foolscap folders
- GG12FF to suit 1200mm wide unit can take 2 rows of foolscap folders
- Available in white or black finishes
- 10 year warranty

Options:

Product Code	To Suit	Width	Depth	Height
GG09FF	900W Tambour unit	695mm	360mm	95mm
GG12FF	1200W Tambour unit	1020mm	360mm	95mm



Finishes:



GO Slotted Shelf

Features:

- Slotted shelf for use in tambour door cupboards
- Compatible with separate slotted shelf dividers
- Pack of 5 slotted shelf dividers sold separately
- Rear support for dividers
- Reinforced shelf for heavy-duty durability and stability
- Great for dividing documents and folders
- Holds folders vertically
- Available in white or black finishes
- 10 year warranty

Options:

Product Code	To Suit	Width	Depth	Height
GG09SLOT	900W Tambour unit	760mm	380mm	25mm
GG12SLOT	1200W Tambour unit	1050mm	380mm	295mm
GSD7-N	Slotted Shelves	390mm	2mm	185mm



Finishes:





Rapidline Shelving Unit
GSC9422 SG

Specifications:
Overall Size 910W x 400D x 2200H

- Features:**
- Flat packed
 - Clip together - easy to assemble
 - Includes 5 adjustable shelves
 - Available in Silver Grey finish
 - 40kg weight rating per shelf
 - 10 year warranty

Finish:



GO Steel Cupboard
GC10 | GC18 | GC20

Specifications:
GC10 910W x 450D x 1015H
GC18 910W x 450D x 1830H
GC20 910W x 450D x 1981H

- Features:**
- GO steel flush lock cupboard - supplied with 2 keys
 - Available in Graphite Ripple, Silver Grey or White China
 - GCWSG shelf and coat rail as optional extras for use in cupboard
 - 10 year warranty

Finishes:



Office Locker
OFL138N WC

Specifications:
Overall Size 800W x 486D x 1375H

- Features:**
- 6 lockable individual compartments per unit
 - Removable shelf per locker
 - Combination locking system with private and public functions
 - Mail slot on each door and name holder fitted to each door
 - 4 easy adjustable leveling feet
 - Unit finished in white powdercoat
 - 10 year warranty

Finish:



GO Wardrobe
GWA18 SG

Specifications:
Overall Size 910W x 450D x 1830H

- Features:**
- Lockable GO steel swing door wardrobe in Silver Grey
 - Hanging rail and 3 shelves
 - 4 separate storage compartments
 - Fully lockable
 - Supplied with 2 keys
 - 10 year warranty

Finish:



Lectern
LCT12 BL

- Features:**
- Heavy-duty lectern
 - Angled top shelf for presentations
 - Second shelf for storage
 - Black powdercoat finish
 - Detachable adjustable battery powered LED light
 - Lockable castors
 - 8 year warranty

Specifications:

LCT12 BL	Width	Depth	Height
Overall Size	445mm	450mm	1200mm
Top Shelf Size	600mm	400mm	-
Second Shelf Size	550mm	260mm	-



Finish:



Pinboards

- Features:**
- Wall mounted pinboard available in grey
 - Concealed corner wall fixings
 - Felt surface
 - Includes 4 pins
 - Galvanised steel backing
 - Low density fibreboard core
 - 8 year warranty

Options:

Product Code	Width	Depth	Height
PIN96	900mm	15mm	600mm
PIN129	1200mm	15mm	900mm
PIN1212	1200mm	15mm	1200mm
PIN159	1500mm	15mm	900mm
PIN1512	1500mm	15mm	1200mm
PIN189	1800mm	15mm	900mm
PIN1812	1800mm	15mm	1200mm
PIN2412	2400mm	15mm	1200mm



Finishes:



Corkboards

- Features:**
- Composite corkboard with aluminium frame
 - Concealed corner wall fixings
 - Suitable for pins or stickers
 - 8 year warranty

Options:

Product Code	Width	Depth	Height
C96	900mm	15mm	600mm
C129	1200mm	15mm	900mm
C1212	1200mm	15mm	1200mm
C159	1500mm	15mm	900mm
C1512	1500mm	15mm	1200mm
C189	1800mm	15mm	900mm
C1812	1800mm	15mm	1200mm
C2412	2400mm	15mm	1200mm



Finish:



Whiteboards

Features:

- Wall mounted aluminium frame
- Magnetic surface
- Pen tray and 4 x magnets included
- Concealed corner fixing
- Acrylic polyester resin
- Includes fixing screws
- 8 year warranty

Options:

Product Code	Width	Depth	Height
W96	900mm	15mm	600mm
W129	1200mm	15mm	900mm
W1212	1200mm	15mm	1200mm
W159	1500mm	15mm	900mm
W1512	1500mm	15mm	1200mm
W189	1800mm	15mm	900mm
W1812	1800mm	15mm	1200mm
W219	2100mm	15mm	900mm
W2112	2100mm	15mm	1200mm
W2412	2400mm	15mm	1200mm



Finish:



Porcelain Whiteboards

Features:

- Porcelain / Vitreous enamel surface (Polyvision E3 ceramic steel)
- Includes 4 x magnets
- Includes fixing screws
- Includes pen tray
- 25 year warranty

Options:

Product Code	Width	Depth	Height
PWB96	900mm	15mm	600mm
PWB129	1200mm	15mm	900mm
PWB1212	1200mm	15mm	1200mm
PWB159	1500mm	15mm	900mm
PWB1512	1500mm	15mm	1200mm
PWB189	1800mm	15mm	900mm
PWB1812	1800mm	15mm	1200mm
PWB2112	2100mm	15mm	1200mm
PWB2412	2400mm	15mm	1200mm
PWB3012	3000mm	15mm	1200mm



Finish:



Glassboards

Features:

- Compatible with any whiteboard markers or liquid chalk markers
- Super clear 4mm toughened glassboard
- Magnetic surface - requires strong magnets. Includes 4 x magnets
- Galvanised steel backing
- 25mm chrome fittings
- 25 year warranty
- *Markers not included

Options:

Product Code	Width	Depth	Height
GB96	900mm	15mm	600mm
GB129	1200mm	15mm	900mm
GB159	1500mm	15mm	900mm
GB1512	1500mm	15mm	1200mm
GB189	1800mm	15mm	900mm
GB1812	1800mm	15mm	1200mm
GB2112	2100mm	15mm	1200mm
GB2412	2400mm	15mm	1200mm



Finish:



Mobile Whiteboards

Features:

- Mobile whiteboard with castors
- Includes pen tray and 4 x magnets
- Double sided laquered steel
- Magnetic surface
- 8 year warranty

Options:

Product Code	Board Width	Board Height	Overall Width	Overall Depth	Overall Height
MW12960	1200mm	900mm	1330mm	550mm	1770mm
MW15960	1500mm	900mm	1630mm	550mm	1770mm
MW1512	1500mm	1200mm	1630mm	550mm	1770mm
MW18960	1800mm	900mm	1930mm	550mm	1770mm
MW1812	1800mm	1200mm	1930mm	550mm	1770mm



Finish:



Porcelain Mobile Whiteboards

Features:

- Mobile whiteboard with castors
- Pivoting
- Double sided
- Porcelain / Vitreous enamel surface (Polyvision E3 ceramic steel)
- Includes pen tray and 4 x magnets
- 25 year warranty

Options:

Product Code	Board Width	Board Height	Overall Width	Overall Depth	Overall Height
PMW129	1200mm	900mm	1330mm	550mm	1770mm
PMW1512	1500mm	1200mm	1630mm	550mm	1770mm
PMW1812	1800mm	1200mm	1930mm	550mm	1770mm



Finish:



Free Standing Screens

Features:

- Free standing dividing office panels for privacy and noise reduction
- Pinnable fabric with black PVC edging
- Screen available in grey or blue fabric
- Silver freestanding feet
- 5 year warranty
- * Customisable Rapidline upholstery available

Options:

Product Code	Width	Depth	Height
A1518	1500mm	50mm	1800mm
A1818	1800mm	50mm	1800mm
A1515	1500mm	50mm	1500mm
A1815	1800mm	50mm	1500mm



Finishes:



ACOUSTIC PODS



B.QUIET® Pods

Rapidline B.Quiet® Acoustic Pods are the perfect solution for providing privacy and confidentiality in today's modern open plan office, boasting a Greenguard Gold certification and finish customisation range to suit your needs.

Offering a cost-effective and efficient way to ensure conversations, phone calls, and video conferences remain uninterrupted and private, the B.Quiet® is an excellent addition to any workplace.

With a simple, sleek design, the pod fits effortlessly into any office environment, taking up minimal space and can be relocated when required.



SOUND ABSORBING MATERIALS & CONSTRUCTION



Egg crate acoustic foam

Egg crate foam provides strong noise reduction and is widely used for sound control in recording studios, vocal booths, and control rooms. The foam also assists with reverberation reduction and echo prevention for clear audio.



A sandwich element chassis

Acoustic sandwich elements are made from fire-safe materials including sheet metal, gypsum board, recycled acoustic foam, and acoustic felt with excellent noise-insulating and noise-absorbing properties.



Acoustic absorption panel

Composed of compressed mineral wool or foam, sound absorbing acoustic panels absorb sound waves to reduce general noise, clarify speech, and limit reverberation in walls within enclosed areas.

CONVENIENT PORTABLE & EASY TO ASSEMBLE

Save time

The installation of the Acoustic Pod is quick and efficient. You're not waiting for someone to measure, cut, and assemble each panel. The entire pod is made of prefabricated modules and can be easily installed by a small crew within hours.

Save space

The bottom of the Rapidline Acoustic Pods are fitted with 4 heavy-duty castors for easy movement and relocation. When the pod is in the desired position, the castors can be retracted and leveling feet activated.

Save cost

The Rapidline Acoustic Pods save on material costs, labour, delivery, and storage fees, while providing a space for employees to take private phone calls and host meetings in an open office environment without the need to relocate to a larger office building.



Single Acoustic Pod BQ-SPOD BL-GP18-BK

Specifications:

Overall Size	1030W x 1030D x 2245H
Internal Size	910W x 910D x 2165H
Wall-Mounted Table	600W x 300D (2x 50mm Radius Corners) x 25H
Doorway Width	840
Assembled Weight	310kg

Features:

- Fitted with 1 x LED light (4w 4000k)
- Comes with 2 x ventilation fans, controlled by a door triggered sensor
- Speech level reduction of 30DB
- Air replacement: every 1.2 minutes (total airflow: 1340L/min)
- Fitted with heavy-duty castors for easy movement for relocation
- Exterior finished in black powdercoat
- Interior finished in GP18 dark grey eco panel, with a black melamine table top and dark grey carpet
- 45mm hidden frame glass door, 10mm safety glass to rear & 6mm safety glass to door - finished with black silkscreen print, black powdercoat German doorware, 3 x heavy-duty stainless steel hinges
- Power outlets: Hager Allure WBHP2SUSBAC-MB - 10Amp double internal powerpoint with USB A + USB C charger in matte black
- GreenGuard Gold certified
- 5 year warranty

Customisation

Custom interior and exterior colours available with an 8 week lead time. Please refer to page 131 for customisation options.

Exterior Finish: Interior Finish:



Carpet Finish:



Meeting Acoustic Pod BQ-MPOD BL-GP18-BK

Specifications:

Overall Size	2200W x 1200D x 2245H
Internal Size	2080W x 1080D x 2165H
Table	700W x 500D x 680H
Sofa Overall Size	1070W x 580D x 680H each
Sofa Seat Size	1070W x 450D x 390H (290mm H backrest)
Doorway Width	840
Assembled Weight	560kg

Features:

- 2-4 person meeting pod
- Fitted with 1x LED light (4w 4000k)
- Comes with 4 x ventilation fans, controlled by a door triggered sensor
- Speech level reduction of 30DB
- Air replacement: every 1.8 minutes (total airflow: 2680L/min)
- Fitted with heavy-duty castors for easy movement for relocation
- Exterior finished in black powdercoat
- Interior finished in GP18 dark grey eco panel and dark grey carpet
- Table top finished in black melamine with 2x 50mm radial corners and rectangular flat base underframe. Base finished in black powdercoat
- Sofa finished in 1333 light grey fabric with 30mm black powdercoat tube legs
- 45mm hidden frame glass door, 10mm safety glass to rear & 6mm safety glass to door - finished with black silkscreen print, black powdercoat German doorware, 3x heavy-duty stainless steel hinges
- Power outlets: Hager Allure WBHP2SUSBAC-MB - 10Amp double internal powerpoint with USB A + USB C charger in matte black
- 5 year warranty

Customisation

Custom interior and exterior colours available with an 8 week lead time. Please refer to page 131 for customisation options.

Interior Finish:



Exterior Finish: Table Top Finish:



Sofa Finish:

Carpet Finish:





Custom Order Work Pod
BQ-WPOD-MISC

Specifications:

Overall Size	1615W x 1200D x 2245H
Internal Size	1495W x 1080D x 2165H
Wall-Mounted Table	1074W x 615D x 25H
Doorway Width	840
Assembled Weight	480kg

Features:

- Order in only - approximately 8 week lead time
- Comes with 2 x ventilation fans, controlled by a door triggered sensor
- Fitted with 1x LED light (4w 4000k)
- Speech level reduction of 30DB
- Air replacement: every 1.2 minutes (total airflow: 1340L/min)
- Fitted with heavy-duty castors for easy movement for relocation
- 45mm hidden frame glass door, 10mm safety glass to rear & 6mm safety glass to door - finished with black silkscreen print, black powdercoat German doorware, 3x heavy-duty stainless steel hinges
- Power outlets: Hager Allure WBHP2SUSBAC-MB - 10Amp double internal powerpoint with USB A + USB C charger in matte black
- 5 year warranty



Custom Order Large Pod
BQ-LPOD-MISC

Specifications:

Overall Size	2200W x 1500D x 2245H
Internal Size	2080W x 1380D x 2165H
Table	1000W x 500D x 680H
Sofa Overall Size	1370W x 580D x 680H each
Sofa Seat Size	1370W x 450D x 390H (290mm H backrest) each
Doorway Width	840
Assembled Weight	590kg

Features:

- 4-6 person meeting pod
- Order in only - approximately 8 week lead time
- Fitted with 1x LED light (4w 4000k)
- Comes with 8 x ventilation fans, controlled by a door triggered sensor
- Speech level reduction of 30DB
- Air replacement: every 1.6 minutes (total airflow: 4020L/min)
- Fitted with heavy-duty castors for easy movement for relocation
- 45mm hidden frame glass door, 10mm safety glass to rear & 6mm safety glass to door - finished with black silkscreen print, black powdercoat German doorware, 3x heavy-duty stainless steel hinges
- Power outlets: Hager Allure WBHP2SUSBAC-MB - 10Amp double internal powerpoint with USB A + USB C charger in matte black
- 5 year warranty



Colour Chart - Single & Work Pods
8 WEEK LEAD TIME

Exterior Colour Options:



Carpet Colour Options:



Interior Colour Options:

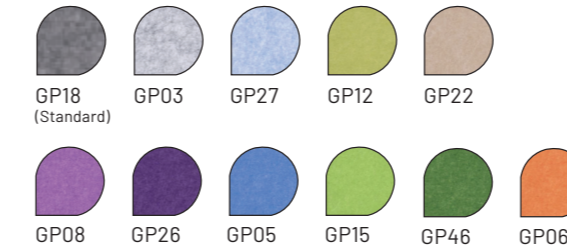
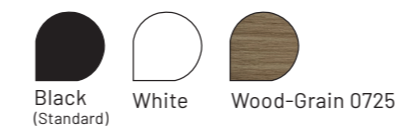

Table Colour Options:



Colour Chart - Meeting & Large Pods
8 WEEK LEAD TIME

Exterior Colour Options:



Carpet Colour Options:



Interior Colour Options:

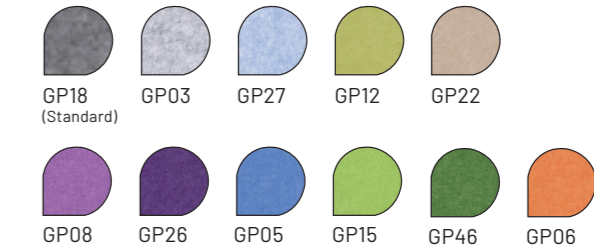

Sofa Colour Options:

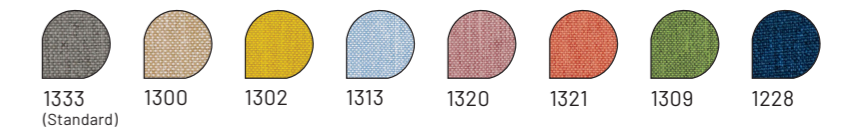

Table Colour Options:



A modern dining area featuring a light-colored wooden table with a dark wood grain. Three grey upholstered chairs are arranged around the table. In the background, a wooden cabinet with a dark top holds a potted plant, a vase, and a stack of papers. A dark tray with three glasses sits on the table.

rapidline